

VENTURI VALVE RETROFIT

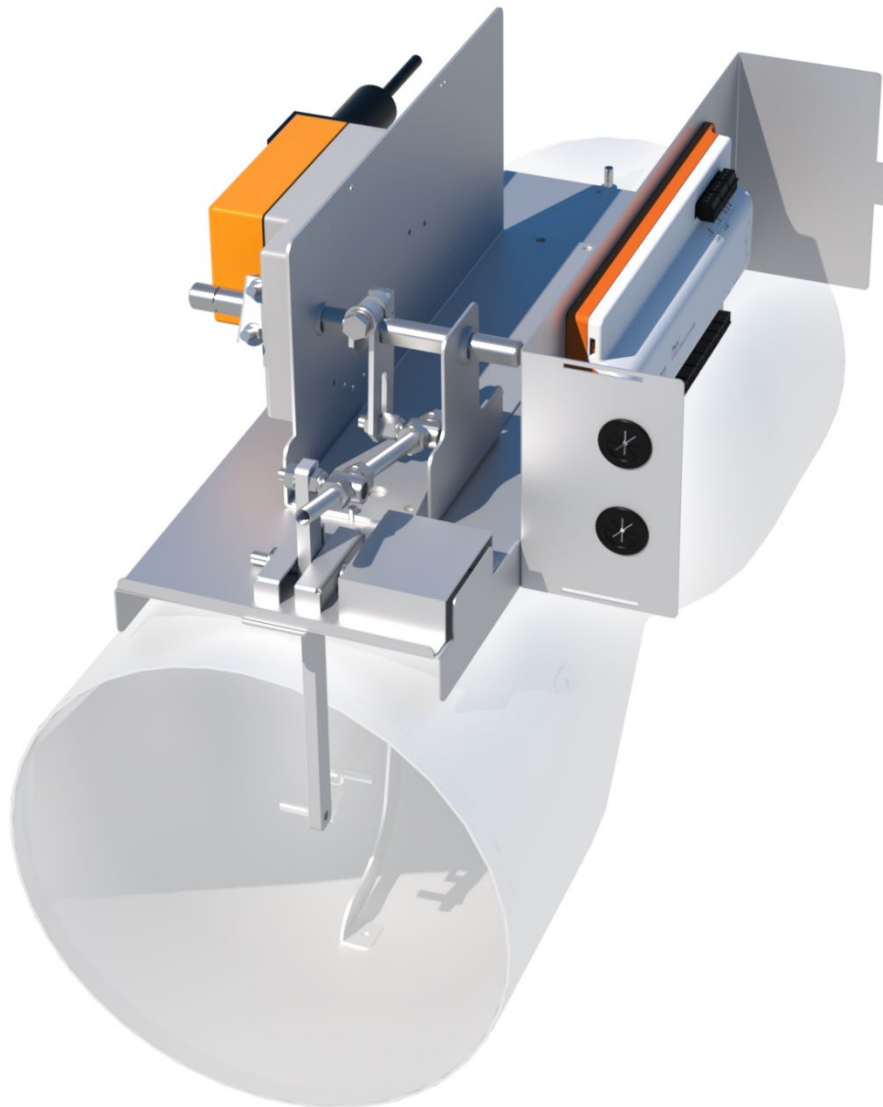

MANUAL v103

ANTEC controls
by price

TABLE OF CONTENTS

| | |
|--|----|
| INTRODUCTION | 1 |
| General | 1 |
| Product Overview | 1 |
| Safety Precautions | 1 |
| GETTING STARTED WITH THE VENTURI VALVE RETROFIT (VVR) | 2 |
| In the Box | 2 |
| Additional Components | 6 |
| Required Tools | 7 |
| Installation and Calibration | 7 |
| When using a VVR with PACE | 7 |
| When using a VVR with CAVA | 7 |
| When using a VVR with the Linear Module (LMX) | 7 |
| When using a VVR with the Fume Hood Controller (FHC) | 7 |
| MOUNTING THE RETROFIT | 8 |
| Mounting Instructions for a Single Valve | 9 |
| Mounting Instructions for a Dual Valve | 16 |
| POTENTIOMETER CURVES | 24 |
| Configuring a POT Curve for PACE or CAVA | 24 |
| Configuring a POT Curve for Fume Hood Controller (FHC) | 28 |
| Configuring a POT Curve for Linear Module (LMX) | 30 |
| Creating a New POT Curve | 32 |
| CALIBRATING THE RETROFIT | 33 |
| Calibrating the Venturi Valve Retrofit when using PACE or CAVA | 33 |
| POTENTIOMETER REPLACEMENT | 37 |
| Potentiometer Replacement | 37 |
| POT CURVE LABELS | 39 |
| BALANCING | 40 |
| Variable Volume Venturi Valve Retrofit (VVR) | 40 |
| Scale Factor | 40 |
| Offset | 40 |
| Recommended Balancing Procedure | 40 |
| TROUBLESHOOTING | 41 |
| Technical Support | 41 |

INTRODUCTION

General

In this manual, you will find information regarding:

- Venturi Valve Retrofit (VVR) specifications
- How to install the VVR with the Pace™ Critical Space Controller (PACE), Fume Hood Valve Module (FVM), the Fume Hood Controller (FHC) and the Linear Module (LMX)
- Detailed description of all options available for each setup and controller

Product Overview

Antec Controls Retrofit are designed to replace obsolete controls on currently installed Venturi Valves. The VVR is built to mount directly onto the existing valves. Retrofits are designed to tether into an existing potentiometer feedback airflow system or airflow sensing system depending on application.

Safety Precautions

- Installation work and electrical wiring must be done by qualified person(s) in accordance with all applicable codes and standards, including fire-rated construction.
- When cutting or drilling into wall or ceiling, do not damage electrical wiring and other hidden utilities.
- Use this unit only in the manner intended by the manufacturer. If you have any questions, contact the manufacturer.
- Before servicing or cleaning unit, switch power off at service panel and lock service panel to prevent power from being switched on accidentally.
- Protect flammable materials nearby when brazing, use flame and heat protection barriers where needed. Always have a fire extinguisher ready.

The manufacturer assumes no responsibility for personal injury or property damage resulting from improper handling, installation, service or operation of the product.



This mark indicates an important point for the proper function of the VVR and any of its accessories. Pay close attention to all caution points throughout this manual.

For support and in-depth training on this product and other associated system components, please contact your local Antec Controls Representative.

For more information visit www.AntecControls.com



GETTING STARTED WITH THE VENTURI VALVE RETROFIT (VVR)

In the Box

For each of the available controllers the order includes the following components outlined in this section.

CAUTION ▼

Please ensure all components are included in the box. Do not proceed if any components are missing, contact your local Antec Controls representative.

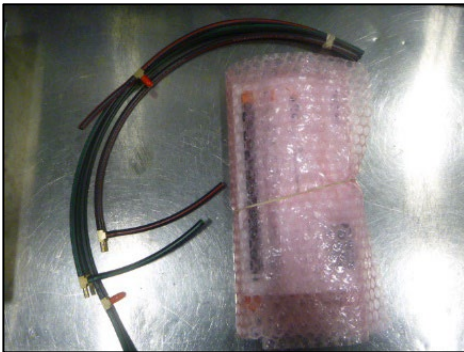

PACE (Single Valve)

The single Venturi Valve Retrofit for PACE ships with several different components. The components are outlined in this section for a single Venturi Valve with a PACE.

| Component | Quantity | Description |
|--------------------------------|----------|--|
| PACE | 1 | Single PACE controller. |
| Green Pressure Tubing | 1 | The low-pressure tubing comes with a length of tubing and a connector tee. |
| Red Pressure Tubing | 1 | The high-pressure tubing comes with a length of tubing and a connector tee. |
| Actuator | 1 | The actuator comes mounted on the mounting bracket and shaft. |
| Mounting Bracket with Linkages | 1 | The single Venturi Valve mounting bracket and linkages comes pre-assembled. The unit just needs to be positioned and fastened with four self-tapping screws. |

NOTE: Unit is shipped with label on the bottom of the PACE to indicate which valve it should be installed on. The image on the left hand side shows the bottom of a PACE with the corresponding identification label.

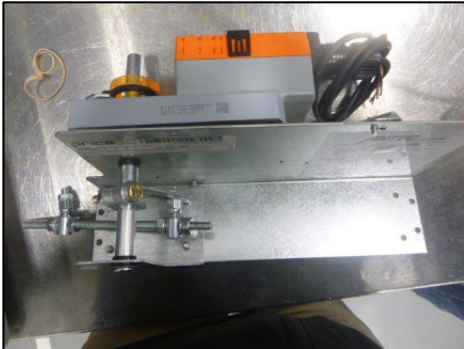

CAUTION ▼

When units are shipped mounted in an enclosure, the label will be shown on the enclosure.

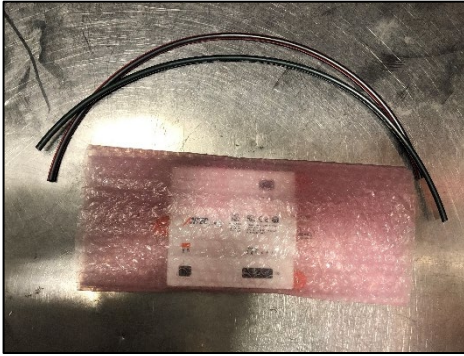

Fume Hood Valve Module (FVM) (Single Valve)

The single Venturi Valve Retrofit for FVM ships with several different components. The components are outlined in this section for a single Venturi Valve with an FVM.

| Component | Quantity | Description |
|--------------------------------|----------|--|
| FVM | 1 | Single FVM controller. |
| Green Pressure Tubing | 1 | The low-pressure tubing comes with a length of tubing and a connector tee. |
| Red Pressure Tubing | 1 | The high-pressure tubing comes with a length of tubing and a connector tee. |
| Actuator | 1 | The actuator comes mounted on the mounting bracket and shaft. |
| Mounting Bracket with Linkages | 1 | The single Venturi Valve mounting bracket and linkages comes pre-assembled. The unit just needs to be positioned and fastened with four self-tapping screws. |

NOTE: Unit is shipped with label on the bottom of the FVM to indicate which valve it should be installed on. The image on the left hand side shows the bottom of an FVM with the corresponding identification label.

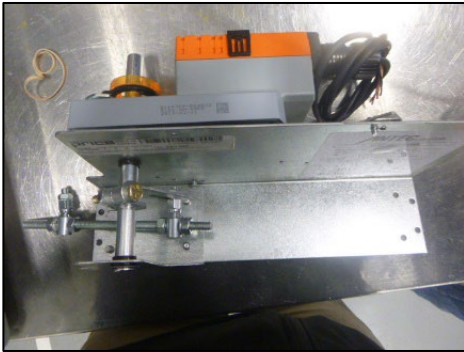

CAUTION ▼

When units are shipped mounted in an enclosure, the label will be shown on the enclosure.

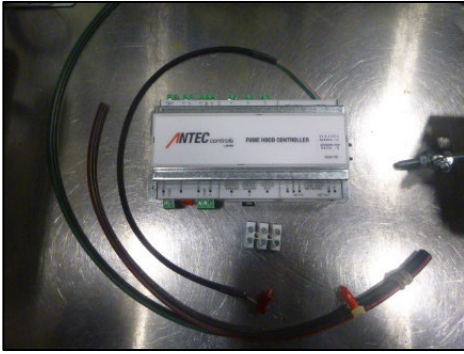

Fume Hood Controller (FHC) (Single Valve)

The single Venturi Valve Retrofit for the FHC ships with several different components. The components are outlined in this section for a single Venturi Valve with an FHC.

| Component | Quantity | Description |
|--------------------------------|----------|--|
| FHC | 1 | Single FHC controller. |
| FHC Mounting Bracket | 1 | Bracket used to mount the FHC to the controls enclosure. |
| Potentiometer Cable | 1 | Cable used to connect the FHC to the existing potentiometer. |
| Green Pressure Tubing | 1 | The low-pressure tubing comes with a length of tubing and a connector tee. |
| Red Pressure Tubing | 1 | The high-pressure tubing comes with a length of tubing and a connector tee. |
| Terminal Block | 1 | Three-pole terminal block that will be used to wire the potentiometer cable to the existing potentiometer |
| Actuator | 1 | The actuator comes mounted on the mounting bracket and shaft. |
| Mounting Bracket with Linkages | 1 | The single Venturi Valve mounting bracket and linkages comes pre-assembled. The unit just needs to be positioned and fastened with four self-tapping screws. |

NOTE: Unit is shipped with label on the bottom of the FHC to indicate which valve it should be installed on. The image on the left hand side shows the bottom of a FHC with the corresponding identification label.

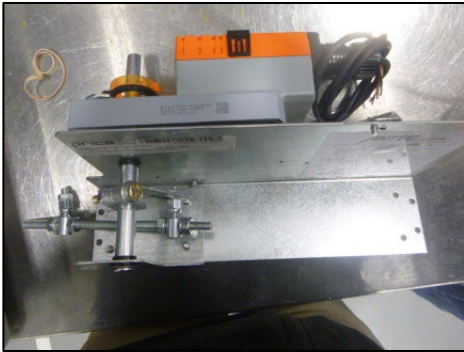

CAUTION ▼

When units are shipped mounted in an enclosure, the label will be shown on the enclosure.

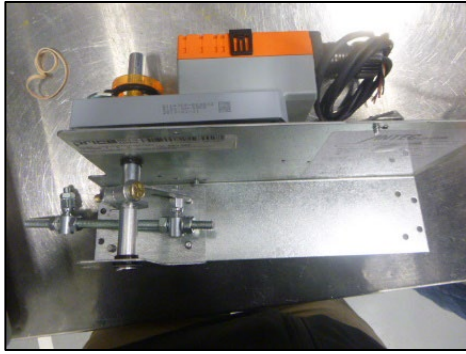

Linear Module (LMX) (Single Valve)

The single Venturi Valve retrofit for LMX ships with several different components. The components are outlined in this section for a single Venturi Valve with an LMX.

| Component | Quantity | Description |
|--------------------------------|----------|--|
| LMX | 1 | Single LMX controller. |
| LMX Mounting Bracket | 1 | Bracket used to mount the LMX to the controls enclosure. |
| Potentiometer Cable | 1 | Cable used to connect the FHC to the potentiometer. |
| Green Pressure Tubing | 1 | The low pressure tubing comes with 29 in. (736.6 mm) of length and a connector tee. |
| Red Pressure Tubing | 1 | The high pressure tubing comes with 18 in. (457.2 mm) of length and a connector tee. |
| Terminal Block | 1 | Three-pole terminal block that will be used to wire the potentiometer cable to the existing potentiometer |
| Actuator | 1 | The actuator comes mounted on the mounting bracket and shaft. |
| Mounting Bracket with Linkages | 1 | The single Venturi Valve mounting bracket and linkages comes pre-assembled. The unit just needs to be positioned and fastened with four self-tapping screws. |

NOTE: Unit is shipped with label on the bottom of the LMX to indicate which valve it should be installed on. The image on the left hand side shows the bottom of a LMX with the corresponding identification label.



When units are shipped mounted in an enclosure, the label will be shown on the enclosure.

Additional Components

The additional components for each available option are outlined in this section.

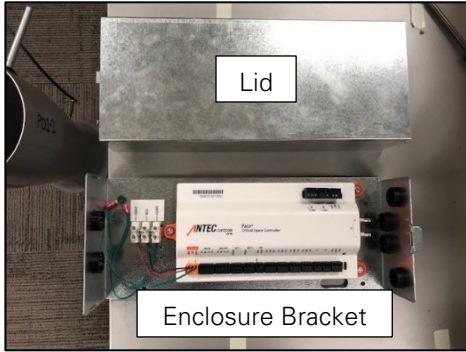

Controls Enclosure

The Venturi Valve Retrofit has an option to order a controls enclosure. The controls enclosure comes with two different components.

| Component | Quantity | Description |
|-------------------|----------|---|
| Enclosure Bracket | 1 | Enclosure bracket mounted to the base plate of the Venturi Valve. |
| Enclosure Lid | 1 | Used to cover the enclosure. |



CAUTION ▼

When units are shipped mounted in an enclosure, the label will be shown on the enclosure.

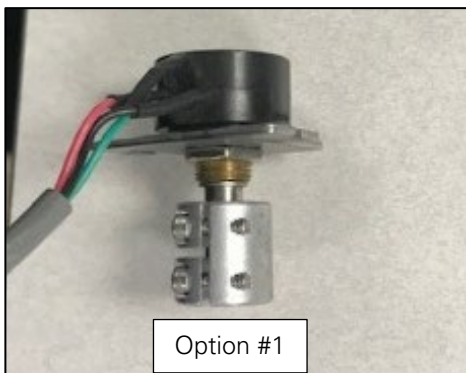

Potentiometer

The Venturi Valve Retrofit may be ordered with a separate replacement potentiometer. The potentiometer comes in two different options.

| Component | Quantity | Description |
|---------------------------|----------|--|
| Potentiometer (Option #1) | 1 | Potentiometer with cable, potentiometer plate, and shaft coupler. This potentiometer assembly is the most commonly used option and is used with base plates that have slotted design |

NOTE: See the [Potentiometer Installation](#) section for more detail.

| | | |
|---------------------------|---|--|
| Potentiometer (Option #2) | 1 | Potentiometer with cable, potentiometer plate, mounting bracket, shaft couplers and extension pin. This potentiometer assembly is required when the existing base plate does not have tab slots. |
|---------------------------|---|--|

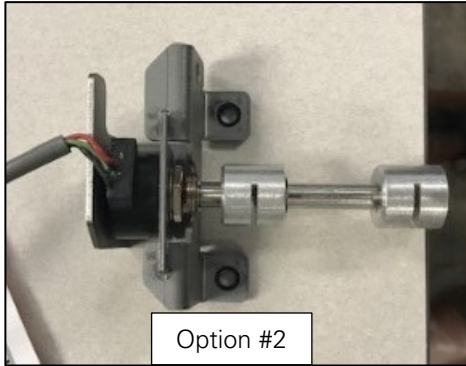

Required Tools

See below for a list of required tools when performing a Venturi Valve Retrofit (VVR) installation.

Installation and Calibration

When installing the controls enclosure and calibrating the linkage, the installer will require the following tools:

- #8 x 5/16" Screws
- Drill
- 1/4" (6.4 mm) Hex Driver
- #2 Phillips Screwdriver
- Controls Screwdriver
- Wire Cutters
- Wire Strippers
- 7/16" (11.1 mm) Wrench (x2)
- 1/2" (12.7 mm) Wrench

When using a VVR with PACE

After installing the VVR, the following tools are required to configure the POT curve for the VVR when using PACE.

- Computer running Windows 7 or higher with Antec Toolbox installed
- Ethernet cable with RJ45 to four-wire connection

NOTE: Please see the [POT Curves – PACE or CAVA](#) section of the manual for connection instructions.

When using a VVR with CAVA

After installing the VVR, the following tools are required to configure the POT curve for the VVR when using CAVA.

- Computer running Windows 7 or higher with Antec Toolbox installed
- Ethernet cable

NOTE: Please see the [POT Curves – PACE or CAVA](#) section of the manual for connection instructions.

When using a VVR with the Linear Module (LMX)

After installing the VVR, the following tools are required to configure the POT curve for the VVR when using an LMX.

- Computer running Windows 7 or higher with Field Flash installed (along with any pre-requisite installers)
- Linker2 Tool
- USB-A to USB-B cable (provided when ordering the Linker2)
- RJ12 Cable

NOTE: Please see the [POT Curves – LMX](#) section of the manual for connection instructions.

When using a VVR with the Fume Hood Controller (FHC)

After installing the VVR, the following tools are required to configure the POT curve for the VVR when using an FHC controller.

- Computer running Windows 7 or higher with Field Flash installed (along with any pre-requisite installers)
- BACnet Commissioning Tool (BCT)
- USB-A to USB-B cable (provided when ordering the BCT)
- Ethernet cable with RJ45 (type B) to three-wire connection

NOTE: Please see the [POT Curves – FHC](#) section of the manual for connection instructions.

MOUNTING THE RETROFIT

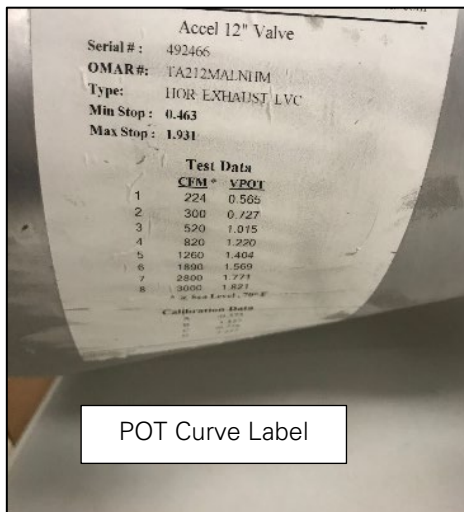

POT Curve Label

Pre-Installation Checks

The following checks are required prior to installation:

- Visually inspect the valve for damage – If damage is found **DO NOT INSTALL**. Please contact an Antec Controls Sales Representative.
- Visually inspect the Retrofit for damage – if damage is found **DO NOT INSTALL**. Please contact Antec Applications.
- Locate the POT Curve Label with the CFM and VPOT points.
- **Verify the potentiometer excitation voltage using a voltmeter, while the original controller or equipment powers it. Measure the voltage across the red and black wires.**

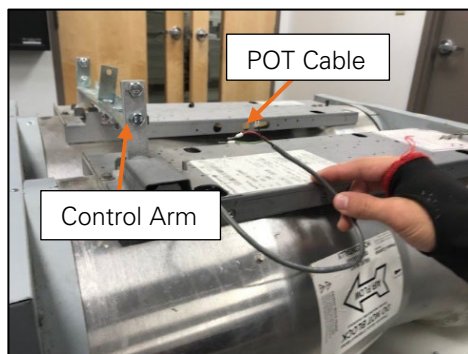

POT Cable

Control Arm

Valve Preparation

The following steps should be performed for any Venturi Valve Retrofit installation.

- Disconnect the three potentiometer (POT) wires from the terminals on the control board.

NOTE: Remove the control components from the base plate on the valve. Components may vary depending on the control solution mounted on the valve but the valve should be left with the control arm, POT and POT wires.



CAUTION ▼

DO NOT cut the POT cable.

The system may still have airflow, to reduce the chance of damage to the existing valve, set the valve to the min position before removing control components.



Mounting Instructions for a Single Valve

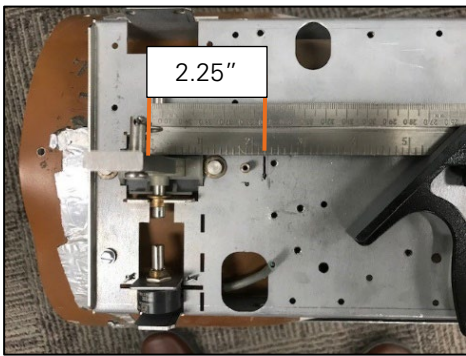

STEP 1

Make a mark 2.25 in. (57.2 mm) from the middle of the control arm shaft.

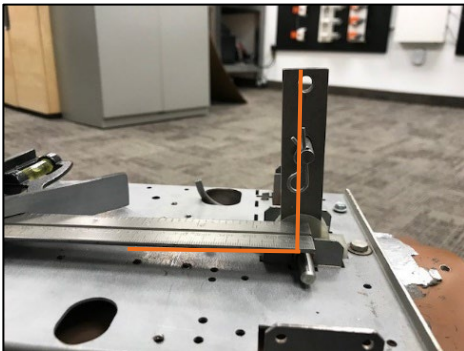

STEP 2

Align the groove so that it's in-line with the pressure tap. Ensure that the bracket is lined up with the 2.25 in. (57.2 mm) mark and is still parallel to the main base plate.

NOTE: Ensure the mounting bracket isn't sitting on top of any hardware.

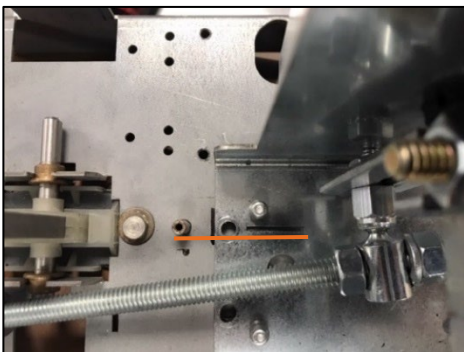

STEP 3

Ensure the edge of the actuator mounting bracket is parallel with the edge of the base plate. Marked by the orange lines in the figure.

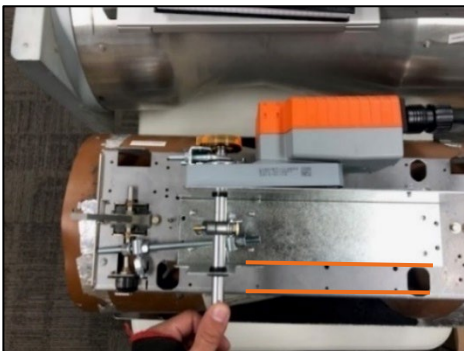

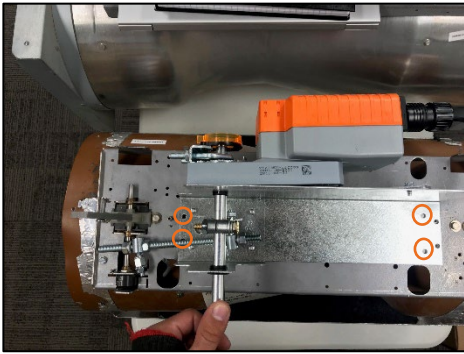

STEP 4

Secure the mounting bracket to the mounting plate of the valve using four 3/8 in. (9.5 mm) self-tapping screws. Pick two holes from the discharge side and two from the inlet side.

NOTE: Self-tapping screws are not provided with the Venturi Valve Retrofit (VVR). The recommended size is a 3/8 in. (9.5 mm) self-tapping screw for metal.



Longer screws (1/2 in. +) can risk damaging the valve coating and penetrating



New Controls Enclosure

STEP 5

If a new controls enclosure is ordered with the VVR, the controller will come factory mounted. The enclosure can be fastened to the base plate with two 3/8 in. (9.5 mm) self-tapping screws.

If re-using the existing controls enclosure, proceed to Step 6.

After mounting the ordered controls enclosure, proceed to Step 11.

NOTE: The ordered controls enclosure comes factory wired with a three-pole terminal block. When using the existing controls enclosure the PACE will ship loose without a three-pole terminal block.

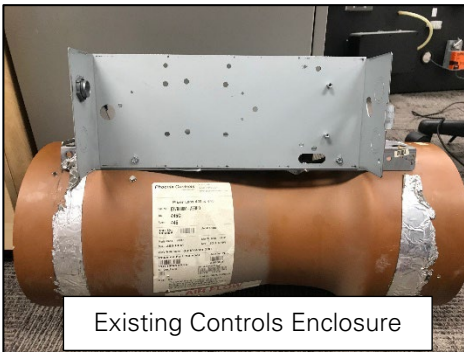

Existing Controls Enclosure

STEP 6

Mount the PACE, Fume Hood Valve Module (FVM), Fume Hood Controller (FHC), or Linear Module (LMX).

For PACE and FVM mounting proceed to Step 7.

For FHC mounting proceed to Step 8.

For LMX mounting proceed to Step 9.

STEP 7

To mount the PACE or FVM, install three self-tapping screws. Two for the holes on the right hand side of the controller and one for the left hand side.

To mount the PACE or FVM in the correct location please follow steps 7A-7C.

NOTE: Self-tapping screws are not provided with the Venturi Valve Retrofit. The recommended size is a 3/8 in. (9.5 mm) self-tapping screw for metal.

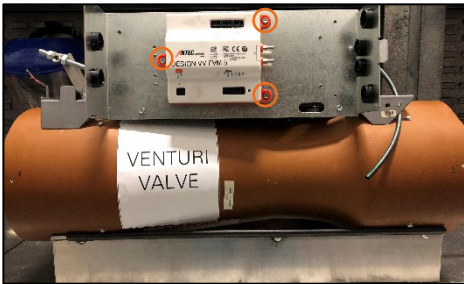

STEP 7A

Mount the device below the top tab insert on the enclosure. There must be a minor gap so the lid of the enclosure can slide on after.





STEP 7B

Pressure ports must be mounted facing the right hand side of the enclosure.
 PACE and FVM are mounted a minimum of 3 in. (76.2 mm) from the right side of the enclosure.

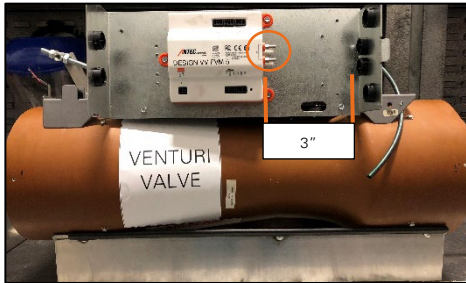

STEP 7C

PACE and FVM are mounted above the base channel on the valve.

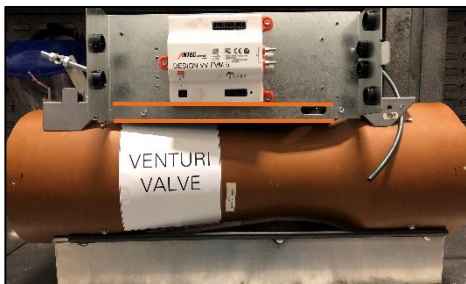

STEP 8

To mount the FHC, use the mounting bracket and install four self-tapping screws.

To mount the FHC in the correct location please ensure the following:

1. The controller leaves enough room for the pressure tubing to be connected.
2. There is sufficient space for the three-pole terminal block to be mounted and wired in.

NOTE: Self-tapping screws are not provided with the Venturi Valve Retrofit. The recommended size is a 3/8 in. (9.5 mm) self-tapping screw for metal.

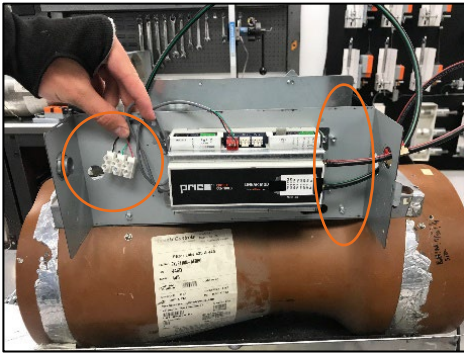

STEP 9

To mount the LMx, use the mounting bracket and install four self-tapping screws.

To mount the LMx in the correct location please ensure the following:

1. The controller leaves enough room for the pressure tubing to be connected.
2. There is sufficient space for the three-pole terminal block to be mounted and wired in.

NOTE: Self-tapping screws are not provided with the Venturi Valve Retrofit. The recommended size is a 3/8 in. (9.5 mm) self-tapping screw for metal.



STEP 10

Mount the three-pole terminal block on the left hand side of the enclosure. The terminal block should be mounted on the opposite side of the pressure tubing. The terminal block can be fastened to the enclosure with two 3/8 in. (9.5 mm) self-tapping screws for metal.

STEP 11

Connect the wiring to the PACE, FHC, or LMx.

For PACE wiring proceed to Step 11A.

For FVM wiring proceed to Step 11B.

For FHC wiring proceed to Step 11C.

For LMx wiring proceed to Step 11D.

STEP 11A

Wire the:

1. Actuator signal wire into AO4 on PACE.
2. POT cable in the POT1 terminal on PACE.
3. Power into the orange power terminal block on PACE.

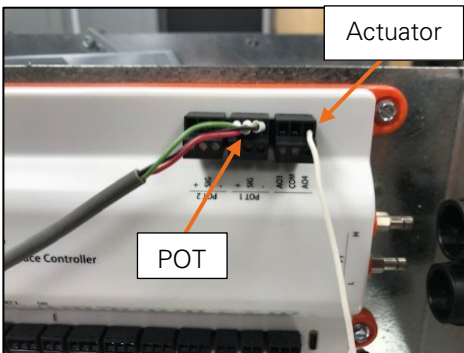
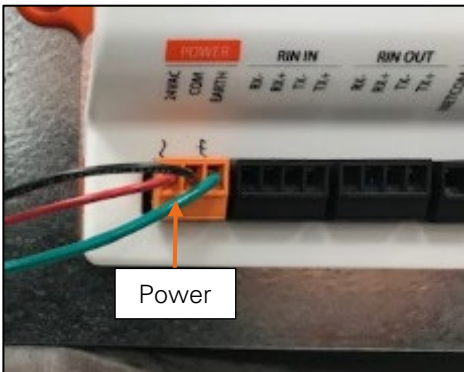

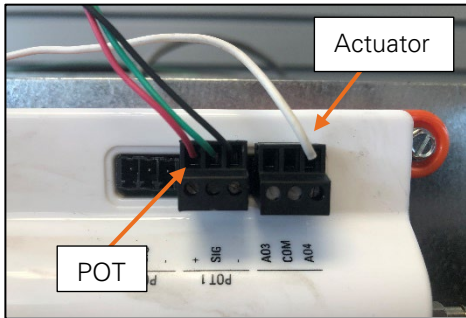
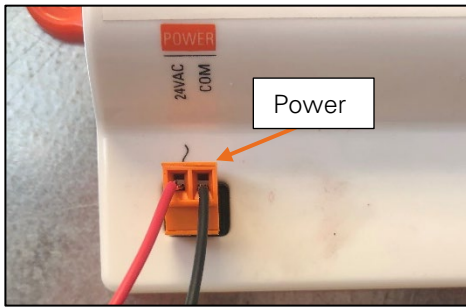

STEP 11B

Wire the:

1. Actuator signal wire to AO4 on the FVM.
2. POT cable to the POT1 terminal on the FVM.
3. Power into the power terminal block on the FVM.

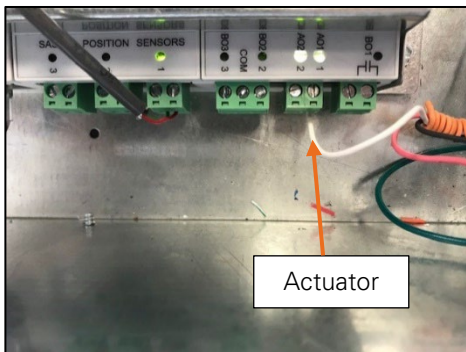

STEP 11C

Wire the:

1. Actuator signal wire to AO1 on the FHC.
2. POT cable to the Venturi POT terminal on the FHC.
3. Power into the power terminal block on the FHC.

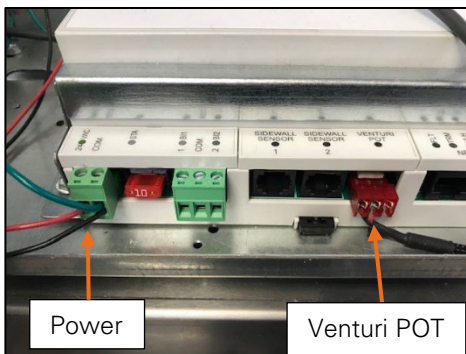



STEP 11D

Wire the:

1. Actuator signal wire to AO1 on the LMX.
2. POT cable to the Venturi POT terminal on the LMX.
3. Flow and pressure signal into the FLO SIG and PRESSURE SIG terminal blocks, respectively.
4. Power into the power terminal block on the LMX.

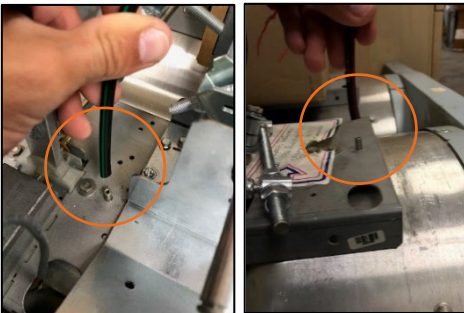
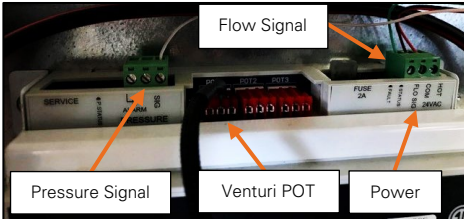

STEP 12

Attach pressure tubing to pressure taps on the valve. Connect the red tube to the high pressure side (inlet) and the green tube to the low pressure side (discharge).

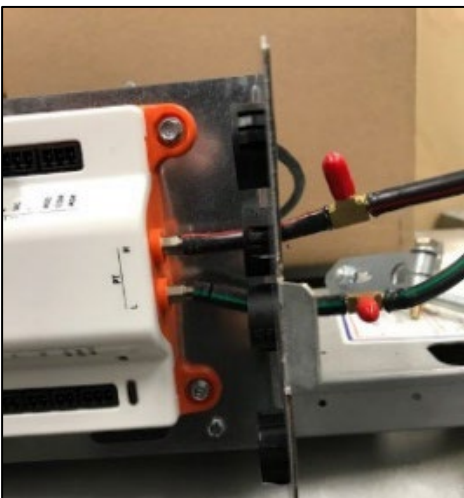

STEP 13

Route the other end of the pressure tubing through the knockout holes to the PACE or FVM pressure taps. Connect the red tubing to the high pressure side (H) and the green tubing to the low pressure side (L).

NOTE: For the LMX and FHC the tap marked with green is for low pressure and the tap marked with red is for high pressure.

STEP 14

Once power is turned on to the unit, please proceed to the [POT Curves](#) section for instructions to configure the controllers POT curves.

Mounting Instructions for a Dual Valve

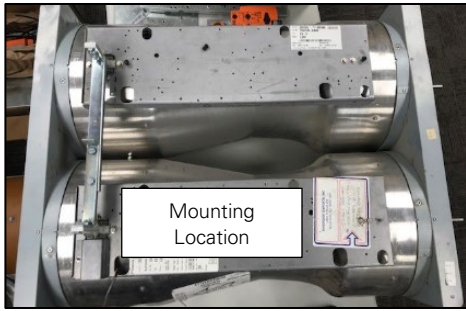

STEP 1

The airflow direction and location of the control arm will determine where the Venturi Valve Retrofit (VVR) is mounted. The VVR will be mounted following the airflow direction on the left hand side valve as shown in the figure.

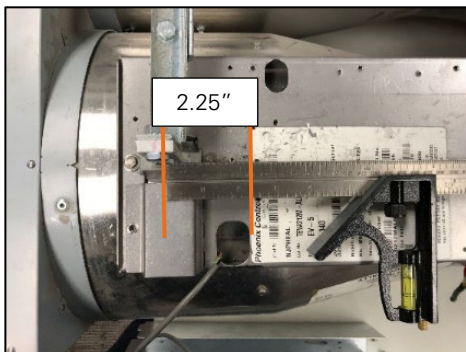

STEP 2

Mark 2.25 in. (57.2 mm) from the middle of the control arm shaft.

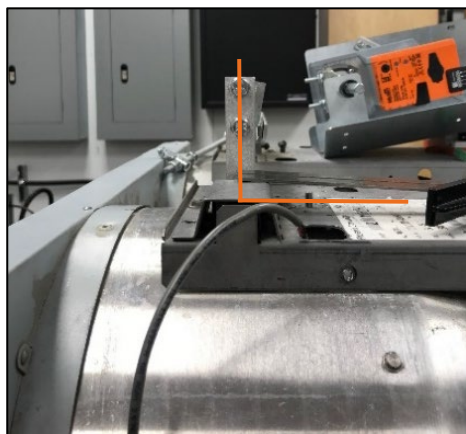



STEP 3

Align the edge of the actuator mounting bracket with the edge of the base plate so they are parallel.

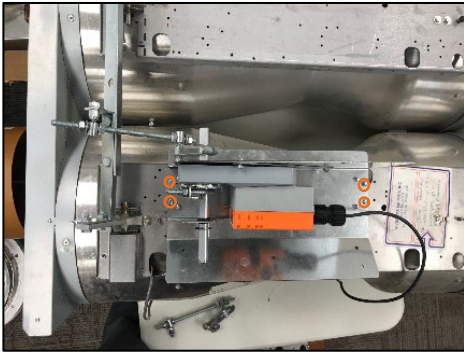

STEP 4

Secure the mounting bracket to the mounting plate of the valve using four self-tapping screws. Pick two holes from the discharge side and two from the inlet side.



CAUTION ▼

Longer screws (1/2 in. or 12.7 mm +) can risk damaging the valve coating and penetrating the valve.



New Controls Enclosure

STEP 5

If a new controls enclosure is ordered with the Venturi Valve Retrofit, the controller will come factory mounted. The enclosure can be fastened to the base plate with two 3/8 in. (9.5 mm) self-tapping screws.

NOTE: The ordered controls enclosure comes factory wired with a three-pole terminal block. When using the existing controls enclosure the PACE will ship loose without a three-pole terminal block.



Existing Controls Enclosure

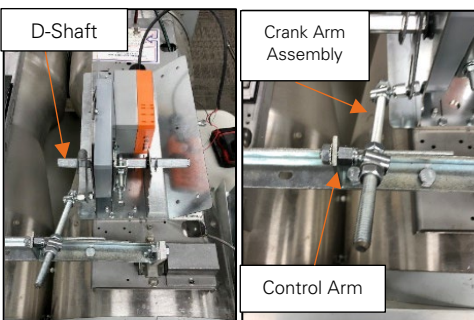

STEP 6A

DUAL (Flat type Base Channels):

Align how indicated thus far.

NOTES:

- The crank arm assembly may need to be slid laterally along the D-shaft and re-tightened to ensure that the threaded position rod is in-line with the control arm.
- The linkage must be attached to the center control arm by sliding the linkage through the hole and fastening it with the nut.

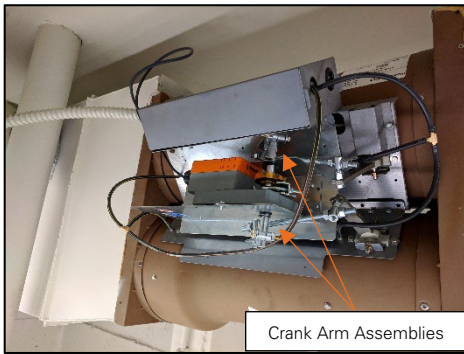

STEP 6B

DUAL (V-type Base Channels):

Align the front edge of the Venturi Valve Retrofit (VVR) 2.25 in. (57.2 mm) from the control arm (as mentioned in the steps above (STEP 2)).

Align VVR baseplate onto base channels such that the angled portion of the base plate sits flush against the base channel and the two crank arm assemblies are positioned approximately in-line with the two control arms. The linkage will must be attached to the center control arm by sliding the linkage through the hole and fastening it with the nut.

STEP 7

Mount the PACE, Fume Hood Valve Module (FVM), Fume Hood Controller (FHC), or Linear Module (LMX).

For PACE and FVM mounting proceed to Step 8.

For FHC mounting proceed to Step 9.

For LMX mounting proceed to Step 10.



STEP 8

To mount the PACE or FVM, install three self-tapping screws. Two for the holes on the right hand side of controller and one for the left hand side.

To mount the PACE or FVM in the correct location please follow steps 8A-8C.

NOTE: Self-tapping screws are not provided with the VVR. The recommended size is a 3/8 in. (9.5 mm) self-tapping screw for metal.





STEP 8A

Mount the PACE and FVM below the top tab insert on the enclosure. There must be a minor gap so the lid of the enclosure can slide on after.



STEP 8B

Pressure ports must be mounted facing the right-hand side of the enclosure. PACE and FVM are mounted a minimum of 3 in. (76.2 mm) from the right side of the enclosure.

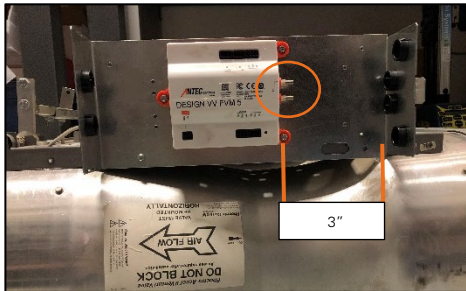
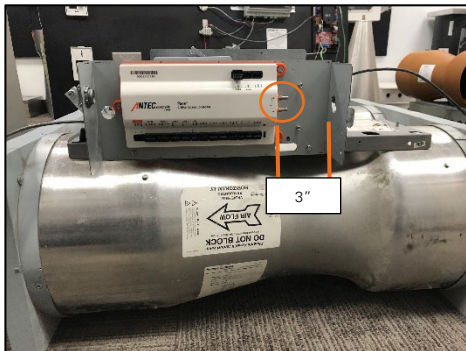



STEP 8C

PACE and FVM are mounted above the base channel on the valve.

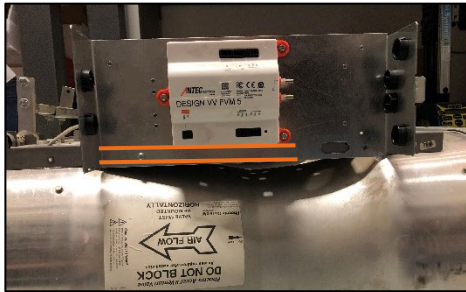

STEP 9

To mount the FHC, use the mounting bracket and install four self-tapping screws.

To mount the FHC in the correct location please ensure the following:

1. The controller leaves enough room for the pressure tubing to be connected.
2. There is sufficient space for the three-pole terminal block to be mounted and wired in.

NOTE: Self-tapping screws are not provided with the Venturi Valve Retrofit (VVR). The recommended size is a 3/8 in. (9.5 mm) self-tapping screw for metal.

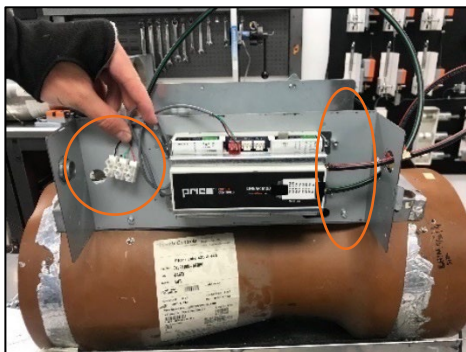

STEP 10

To mount the LMX, use the mounting bracket and install four self-tapping screws.

To mount the LMX in the correct location please ensure the following:

1. The controller leaves enough room for the pressure tubing to be connected.
2. There is sufficient space for the three-pole terminal block to be mounted and wired in.

NOTE: Self-tapping screws are not provided with the VVR. The recommended size is a 3/8 (9.5 mm) in. self-tapping screw for metal.



STEP 11

Mount the three-pole terminal block with two self-tapping screws.

NOTE: Self-tapping screws are not provided with the VVR. The recommended size is a 3/8 in. (9.5 mm) self-tapping screw for metal.

STEP 12

Connect the wiring to the PACE, FVM, FHC, or LMX.

For PACE wiring proceed to Step 12A.

For FVM wiring proceed to Step 12B.

For FHC wiring proceed to Step 12C.

For LMX wiring proceed to Step 12D.

STEP 12A

Wire the:

1. Actuator signal wire into AO4 on PACE.
2. POT cable in the POT1 terminal on PACE.
3. Power into the orange power terminal block on PACE.

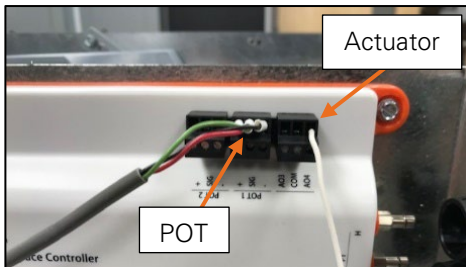
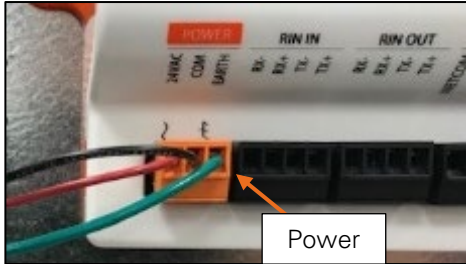

STEP 12B

Wire the:

1. Actuator signal wire to AO4 on the FVM.
2. POT cable to the POT1 terminal on the FVM.
3. Power into the power terminal block on the FVM.

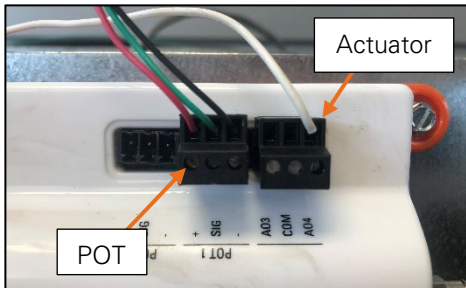
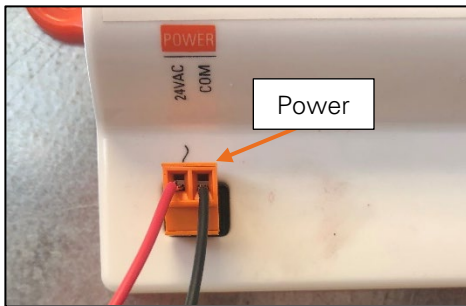

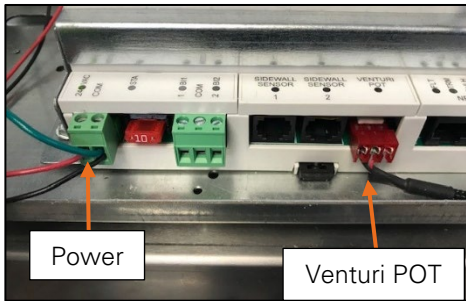
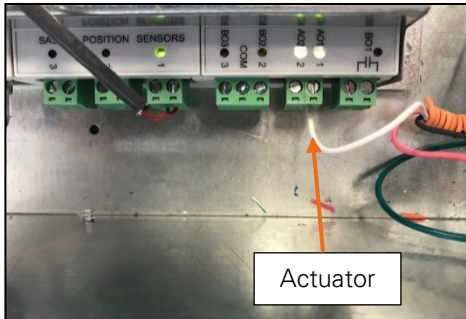

STEP 12C

Wire the:

1. Actuator signal wire to AO1 on the FHC.
2. POT cable to the Venturi POT terminal on the FHC.
3. Power into the power terminal block on the FHC.

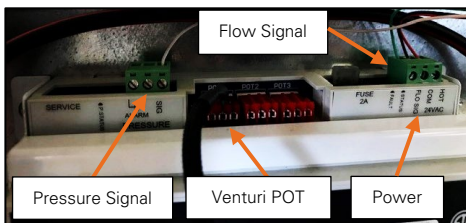

STEP 12D

Wire the:

1. Actuator signal wire to AO1 on the LMX.
2. POT cable to the Venturi POT terminal on the LMX.
3. Flow and pressure signal into the FLO SIG and PRESSURE SIG terminal blocks, respectively.
4. Power into the power terminal block on the LMX.



STEP 13

Attach pressure tubing to pressure taps on the valve. Connect the red tube to the high pressure side (inlet) and the green tube to the low pressure side (discharge).

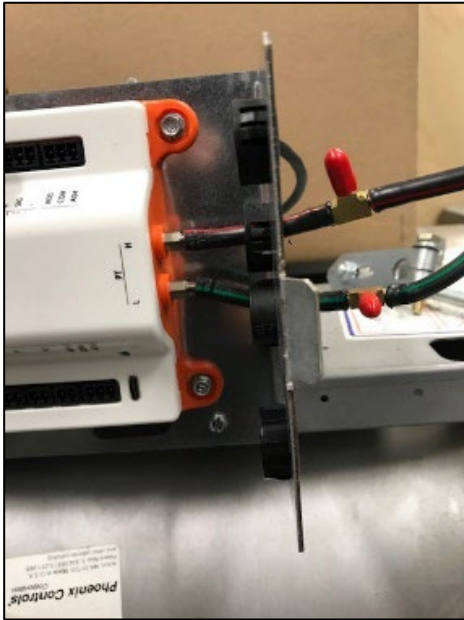
**STEP 14**

Route the other end of the pressure tubing through the knockout holes to the PACE or FVM pressure taps. Connect the red tubing to the high pressure side (H) and the green tubing to the low pressure side (L).

NOTE: For the LMX and FHC the tap marked with green is for low pressure and the tap marked with red is for high pressure.

STEP 15

Once power is turned on to the unit, please proceed to the [POT Curves](#) section for instructions to configure the controllers POT curves.

POTENTIOMETER CURVES

Potentiometer (POT) curves are required any time a Venturi Valve Retrofit (VVR) is installed on an existing Venturi Valve in the field. If provided by the original manufacturer or the building owner, this curve can be configured by the factory prior to shipping the VVR.

If the POT curve has been configured by the factory, please skip to the [Calibration Section](#) of this manual.

If the POT curve has not been configured by the factory, please see below for instructions to configure a POT curve onto a VVR when using either the [PACE or CAVA](#), [Fume Hood Controller \(FHC\)](#) or the [Linear Module \(LMX\)](#).

Configuring a POT Curve for PACE or CAVA

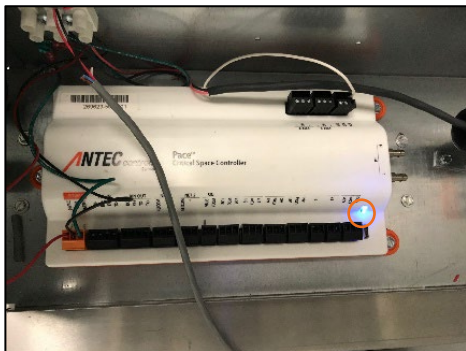

STEP 1

Ensure the unit is powered and has a BLUE light.

NOTE: Please see the PACE and CAVA Manuals for power requirements.



If applying temporary power to configure the POT curve and none of the other controllers on RIN are powered. Ensure to remove the room configuration after completing the POT curve configuration.

STEP 2

Step 2A outlines instructions for connecting directly to PACE.

Step 2B outlines instructions for connecting directly to CAVA.

NOTE: For more information on connecting to PACE or CAVA please refer to the Toolbox manual.



STEP 2A

Connect a computer to PACE by using either the Keystone Jack (CKJ) or by connecting directly to PACE.

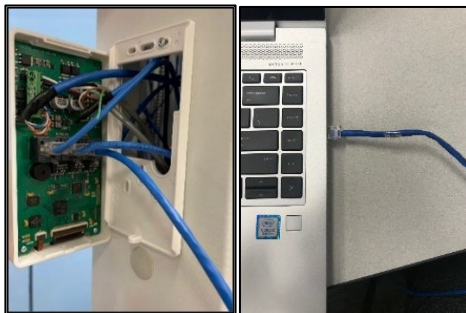

STEP 2B

Connect a computer to CAVA by using one of the available ports on the back of the device.

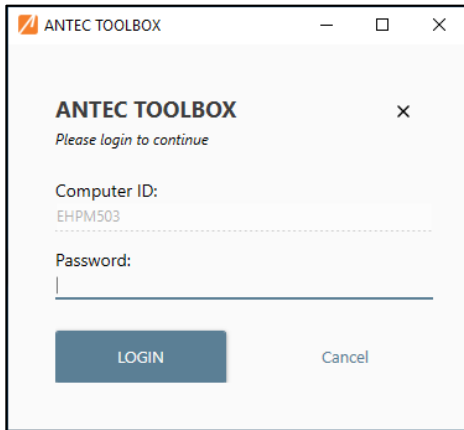

STEP 3

Open Antec Toolbox while connected to PACE or CAVA.

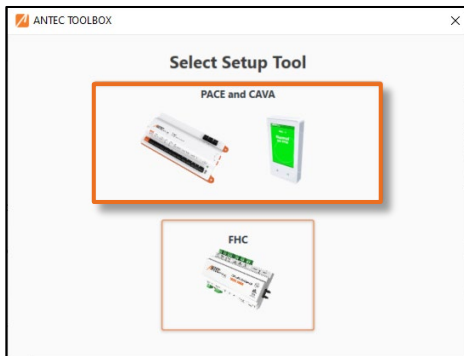

STEP 4

Click on PACE and CAVA to enter their respective section of the software.

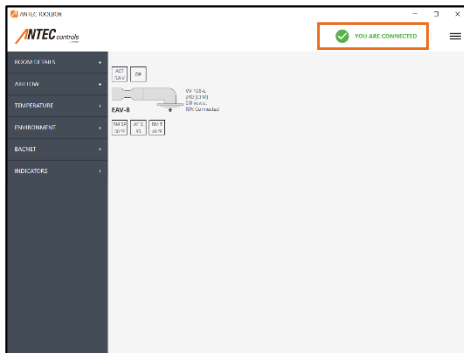

STEP 5

Toolbox will begin by loading linestrings.

After this is complete, all PACE and/or FVM detected on the Room Information Network (RIN) will be displayed on the home screen.

NOTE: If configuring POT curves for the whole room, all valves should be visible.

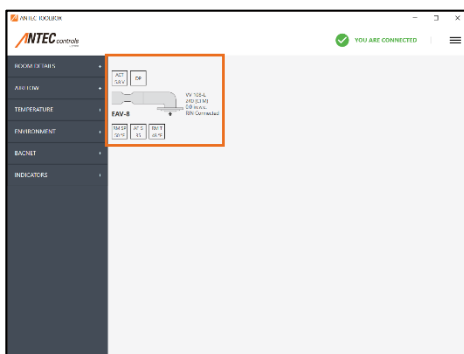

STEP 6

Click on the valve that requires a POT curve.

NOTE: The valve tag should populate and VVR should be displayed just to the right of the valve icon.

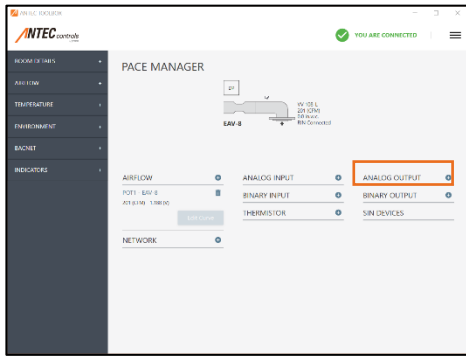

STEP 7

Add an actuator as an analog output. Add any additional inputs or outputs as necessary.



CAUTION

For Single and Dual valves (One POT Curve), only one airflow device is required. For Triple valves (Two POT Curves), two airflow devices are required. Ensure the correct POT curve is configured for the correct airflow device.

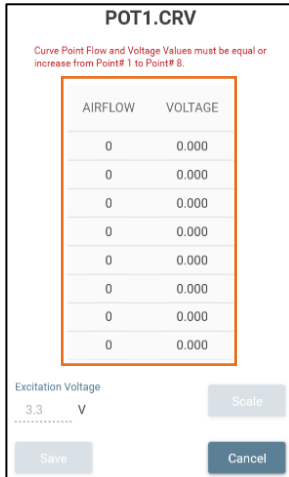

STEP 8

The edit airflow menu will appear as zeros for all airflow and voltage values. Enter the eight airflow and voltage values for the original POT curve.

NOTE: This information should come from the previous manufacturer. If this is not available, please skip to [Creating a New POT Curve](#).

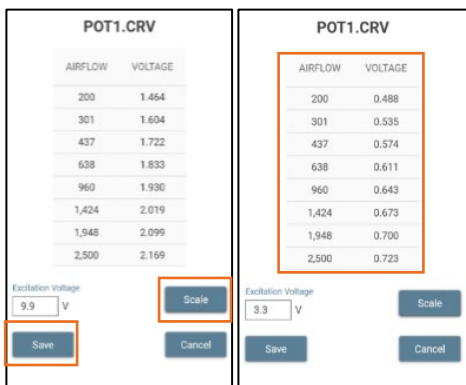
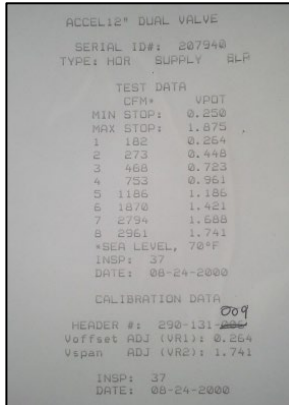

STEP 9

Enter the excitation voltage that was used to originally create the POT curve. Then select scale. This will edit the POT curve to the excitation voltage of either the PACE or CAVA based on the controller in use.

NOTES:

1. PACE uses an excitation voltage of 3.3 V.
2. CAVA uses an excitation voltage of 3.0 V.



CAUTION

Different manufacturers use different excitation voltages for their controls. It is recommended that before removing the old controls, the excitation voltage is verified with a physical measurement.

POT1.CRV

| AIRFLOW | VOLTAGE |
|---------|---------|
| 200 | 1.464 |
| 301 | 1.604 |
| 437 | 1.722 |
| 638 | 1.833 |
| 960 | 1.930 |
| 1,424 | 2.019 |
| 1,948 | 2.099 |
| 2,500 | 2.169 |

Excitation Voltage: V

STEP 10

Select save and exit the menu.

NOTE: A message should appear in the snack bar “Curve for POT 1 sent to VALVE TAG successfully.”

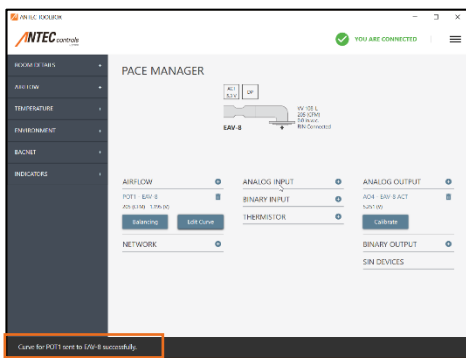

Step 11

Using the Menu Button dropdown in the top right corner of the Toolbox window, click Diagnostics. Click on Remove Room Configuration to remove the configuration file for the room.

NOTE: Configure the whole room after each Venturi Valve Retrofit controller has a POT curve.

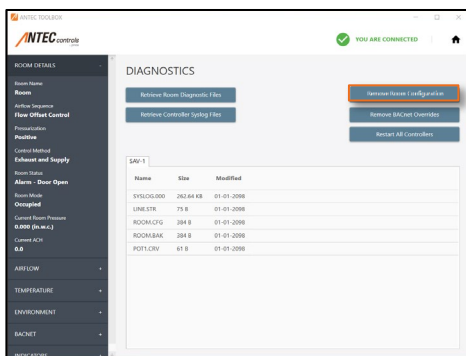
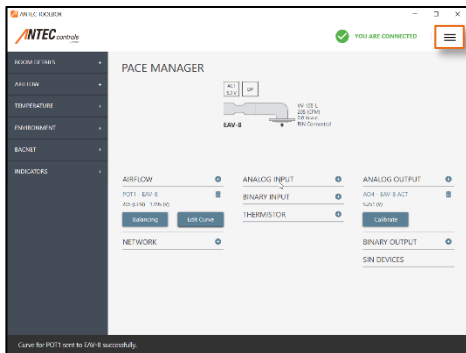

Configuring a POT Curve for Fume Hood Controller (FHC)



STEP 1

Ensure the unit has power.

NOTE: Please see the FHC Manual for power requirements.



Before attempting to connect to the FHC, ensure that the Network Type is set to Mnet and the Mnet Address is set to 1.

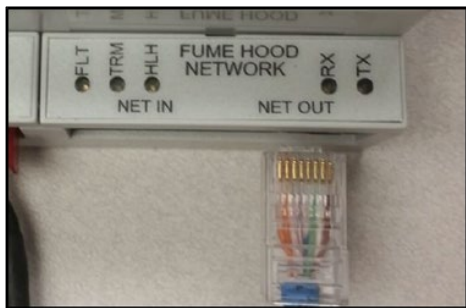

STEP 2

Using the Ethernet cable described in the [Required Tools](#), connect the RJ45 end to the NET OUT port on the FHC and wire the three-wire connection to the BCT using the following wiring:

| BCT Terminal | Wire Colour (PIN) |
|--------------|----------------------|
| MS/TP COM | Brown (PIN 8) |
| MS/TP A+ | Orange/White (PIN 1) |
| MS/TP B- | Orange (PIN 2) |



Disconnect all wires on NET IN.

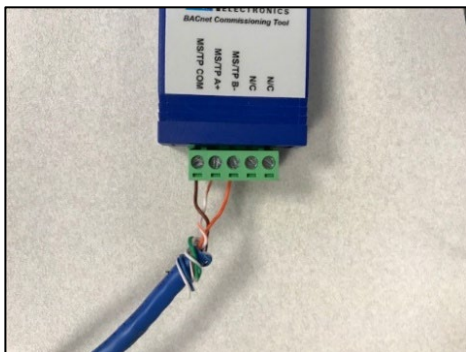

STEP 3

Connect the BCT to the laptop using the USB-A to USB-B cable.

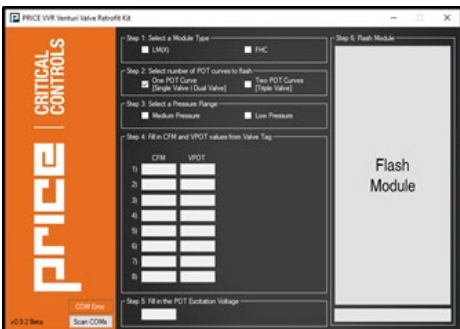

STEP 4

Open the Field Flash program.



If experiencing a connection issue to the FHC, unplug any unneeded USB devices and disconnect any Bluetooth devices from the computer before starting the program.

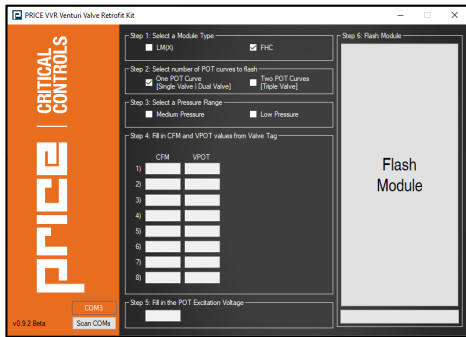

STEP 5

The program will automatically detect a COM port that is communicating with the Fume Hood Controller (FHC). If a COM port is not automatically detected, use the Scan COMs button to scan again. If connection is still not detected, please proceed to the [Troubleshooting](#) section of the manual.

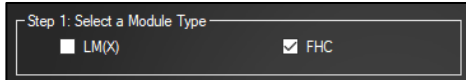

STEP 6

After a module is found, confirm the Module Type is shown as FHC.

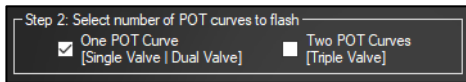

STEP 7

Select whether the valve has One POT Curve or Two POT Curves.

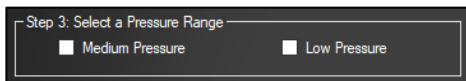

STEP 8

Select the operating range of the valve.

NOTES:

- Low pressure valves have a pressure range of 0.3 to 3.0 in.w.c (74.6 to 746.5 Pa)
- Medium pressure valves have a pressure range of 0.6 to 3.0 in.w.c (149.3 to 746.5 Pa)

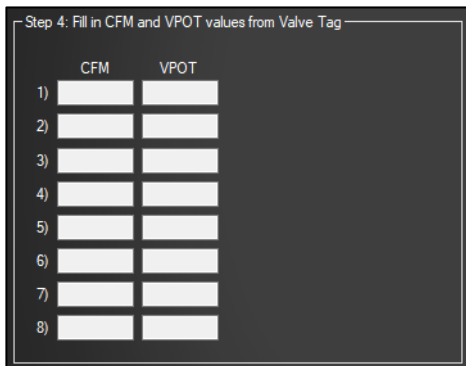

STEP 9

Enter the eight airflow and voltage values for the original POT curve.

NOTE: This information should come from the previous manufacturer. If this is not available, please skip to [Creating a New POT Curve](#).

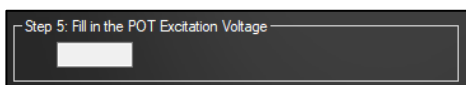

STEP 10

Enter the excitation voltage that was used to originally create the POT curve.



Different manufacturers use different excitation voltages for their controls. It is recommended that before removing the old controls, the excitation voltage is verified with a physical measurement.

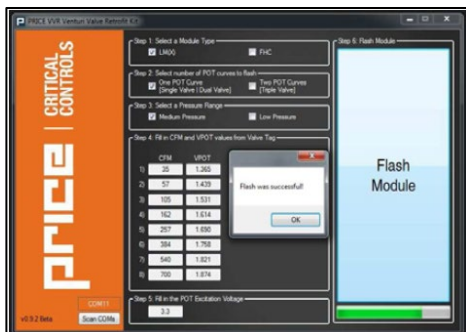

STEP 11

Review your entry and once satisfied click the Flash Module button.

A pop-up will display informing the result of the flash.

Configuring a POT Curve for Linear Module (LMX)



STEP 1

Ensure the unit has power.

NOTE: Please see the LMX Product Submittal for power requirements



STEP 2

Connect the RJ12 cable to the SERVICE port on the LMX.



STEP 3

Connect the Linker2 to the laptop using the USB-A to USB-B cable.

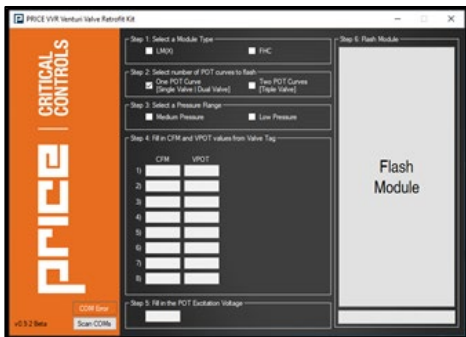

STEP 4

Open the Field Flash program.



CAUTION ▼
If experiencing a connection issue to the LMX, unplug any unneeded USB devices and disconnect any Bluetooth devices from the computer before starting the program.

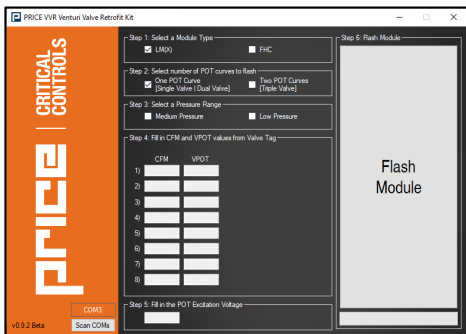

STEP 5

The program will automatically detect a COM port that is communicating with the LMX. If a COM port is not automatically detected, use the Scan COMs button to scan again. If connection is still not detected, please proceed to the [Troubleshooting](#) section of the manual.

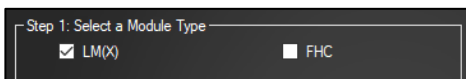

STEP 6

After a module is found, confirm the Module Type is shown as LMX.

Step 2: Select number of POT curves to flash

One POT Curve [Single Valve | Dual Valve] Two POT Curves [Triple Valve]

STEP 7

Select whether the valve has One POT Curve or Two POT Curves.

Step 3: Select a Pressure Range

Medium Pressure Low Pressure

STEP 8

Select the operating range of the valve.

NOTES:

- Low pressure valves have a pressure range of 0.3 to 3.0 in.w.c. (74.6 to 746.5 Pa)
- Medium pressure valves have a pressure range of 0.6 to 3.0 in.w.c. (149.3 to 746.5 Pa)

Step 4: Fill in CFM and VPOT values from Valve Tag

| | CFM | VPOT |
|----|-----|------|
| 1) | | |
| 2) | | |
| 3) | | |
| 4) | | |
| 5) | | |
| 6) | | |
| 7) | | |
| 8) | | |

STEP 9

Enter the eight airflow and voltage values for the original POT curve.

NOTE: This information should come from the previous manufacturer. If this is not available, please skip to [Creating a New POT Curve](#).

Step 5: Fill in the POT Excitation Voltage

STEP 10

Enter the excitation voltage that was used to originally create the POT curve.



CAUTION ▼

Different manufacturers use different excitation voltages for their controls. It is recommended that before removing the old controls, the excitation voltage is verified with a physical measurement.

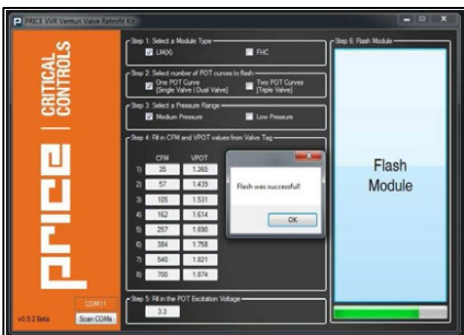

STEP 11

Review your entry and once satisfied click the Flash Module button.

A pop-up will display informing the result of the flash.

Creating a New POT Curve

If the original curve is not available, then it may be necessary to create a new POT curve to use for the valve control.

STEP 1

Begin with the actuator in the minimum position (2 VDC).

Adjust the crank arm and position nuts so that the valve is capable of achieving the minimum rated airflow.

NOTE: Use an airflow measurement tool (such as a Flo-Hood) to verify that the minimum valve airflow is achieved.

STEP 2

Drive the actuator to the maximum position (10 VDC).

Ensure the actuator has reached the maximum position and the valve is capable of achieving the maximum rated airflow.

NOTE: Use an airflow measurement tool (such as a Flo-Hood) to verify that the maximum valve airflow is achieved.

STEP 3

Based on the initial settings used for STEP 1 and the maximum achieved in STEP 2.

- If the valve is not capable of meeting the maximum airflow, return the valve back to minimum position. Increase the crank arm's range and adjust the position nuts until minimum flow is achieved again.
- If the valve's actuator has not reached the maximum position, return the valve back to minimum position. Decrease the crank arm's range and adjust the position nuts until minimum flow is achieved again.

See STEP 6 of the [Calibrating the VVR when using PACE](#) section for more detail.

NOTE: Repeat this step until the minimum and maximum position of the valve are capable of achieving the minimum and maximum operating range of the valve.

STEP 4

After the minimum and maximum position have been achieved, use an actuator override to fill in the following table. This will become the new POT curve for the valve.

After all values have been recorded, please refer back to the previous sections in the [POT Curves](#) section to configure the newly created POT curve.

| Actuator Voltage | POT Voltage (VDC from GREEN to BLACK on POT input) | Airflow (measured by TAB) |
|------------------|--|---------------------------|
| 2.00 | | |
| 3.60 | | |
| 4.90 | | |
| 6.20 | | |
| 7.30 | | |
| 8.30 | | |
| 9.20 | | |
| 10.00 | | |

NOTE: This can be a lengthy process, as it requires taking eight manual readings for POT voltage and airflow.

CALIBRATING THE RETROFIT

Calibration is the process of adjusting the valve's linkage assembly to ensure that the minimum position of the actuator provides the minimum airflow of the valve, and the maximum position of the actuator provides the maximum airflow of the valve.

Calibrating the Venturi Valve Retrofit when using PACE or CAVA

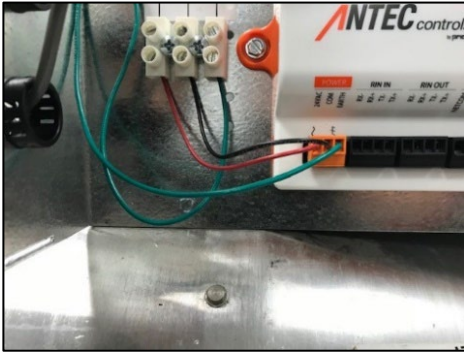

STEP 1

Ensure that there is power to the PACE and that the flow potentiometer has been wired into the controller.

NOTE: If the POT curve is available, ensure it is configured before making any further adjustments.



STEP 2

Step 2A outlines instructions for connecting directly to PACE.

Step 2B outlines instructions for connecting directly to CAVA.

NOTE: For more information on connecting to PACE or CAVA please refer to the Toolbox manual.

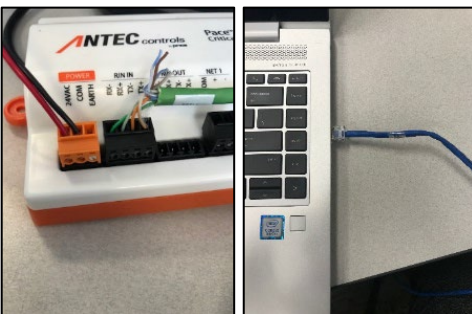

STEP 2A

Connect a computer to PACE by using either the Keystone Jack (CKJ) or by connecting directly to PACE.

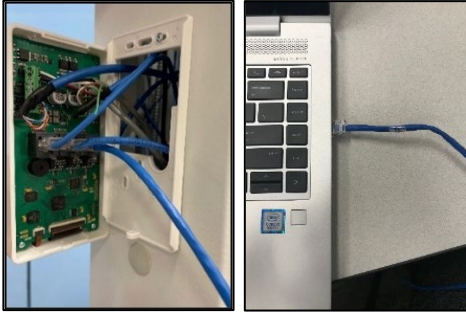

STEP 2B

Connect a computer to CAVA by using one of the available ports on the back of the device.

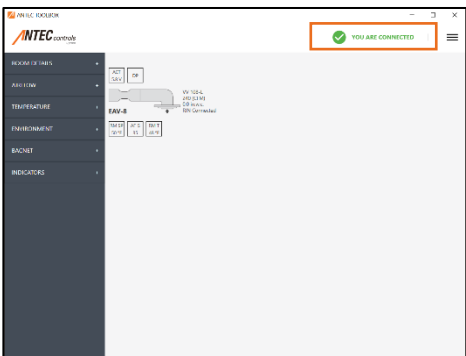

STEP 3

Open Antec Toolbox and navigate to the PACE and CAVA MANAGER screen. Ensure a connected status appears and that the valve(s) populate.

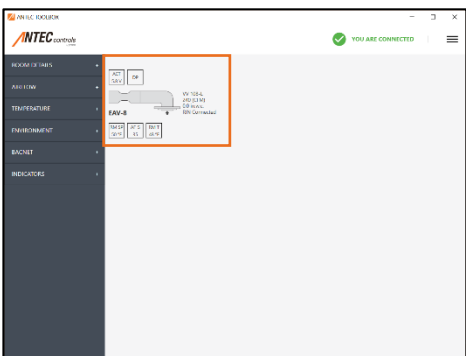

STEP 4

Select the valve you would like to calibrate. Configure the airflow device and actuator in the PACE and CAVA MANAGER screen.

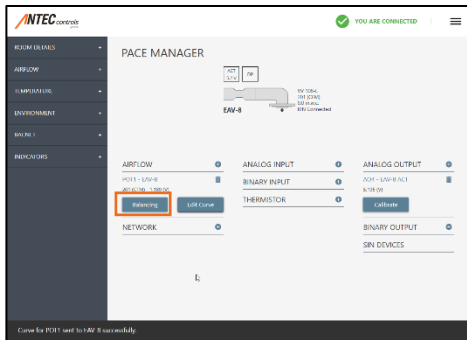

STEP 5

Enter the balancing menu underneath the Airflow tab.

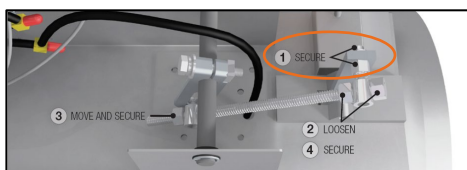
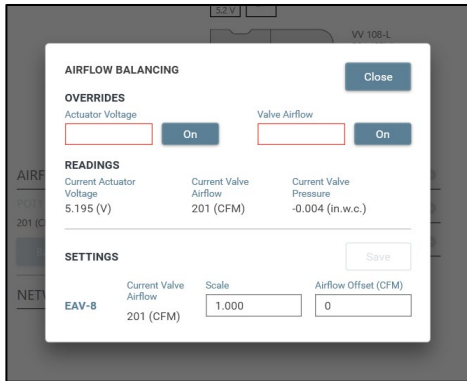

STEP 6

With the valve in the minimum airflow position (2VDC to actuator), loosen the 1/2 in. (12.7 mm) nuts around the swivel nut and fasten it to the control arm on of the valve. Secure the swivel nut with 7/16 in. (11.1 mm) wrenches. Ensure that the minimum flow matches the minimum position in the balancing menu.

NOTES:

- Shifting the position nut towards the crank arm will decrease the flow of the valve.
- Shifting the position nuts away from the crank arm will increase the flow of the valve.
- Small changes of position nuts have small effect on the minimum flow but larger effect on the maximum flow.

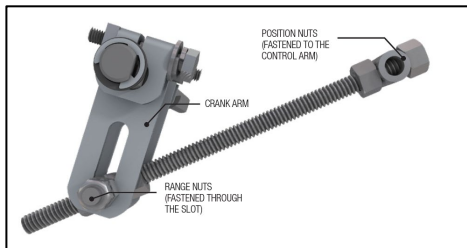

STEP 7

Override the valve from full closed (2 VDC to actuator) to full open (10 VDC to actuator) to see if it matches the full operating range of the valve.

NOTE: This should reach the full operating range, not just the scheduled maximum airflow.

If it matches the range, you have successfully completed the calibration.

If it does not match the range continue to STEP 8.

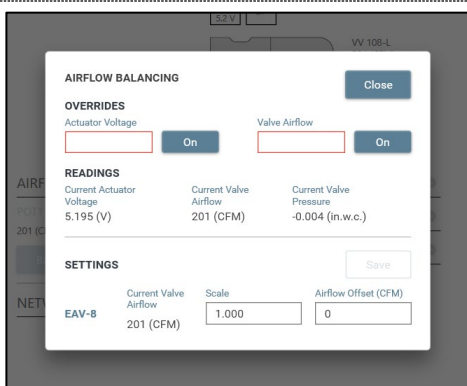

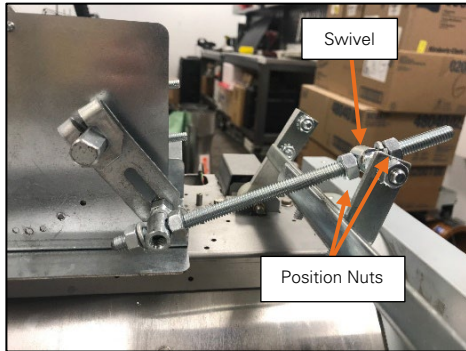
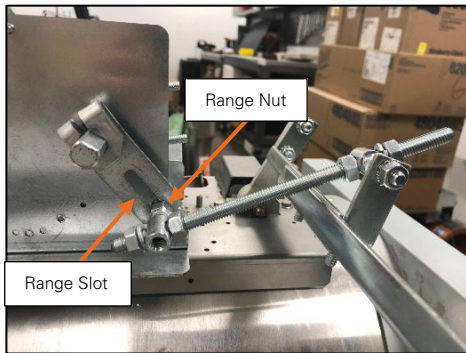
**STEP 8**

If the maximum airflow reading in Step 7 was higher than the operating range move the range nut further up on the range slotted crank arm.

If the maximum airflow reading Step 7 was lower than the operating range move the range nut lower down on the range slotted crank arm.

NOTE: Adjusting the range nut has a smaller effect on the lower end of the valve range and much larger effect on the higher end of the valve range.

STEP 9

Follow Steps 6-8 until the valve operating range matches when the valve is at its minimum and its maximum positions in the balancing menu.

POTENTIOMETER REPLACEMENT

In some cases, it may be appropriate to change the potentiometer on the valve.

Potentiometer Replacement

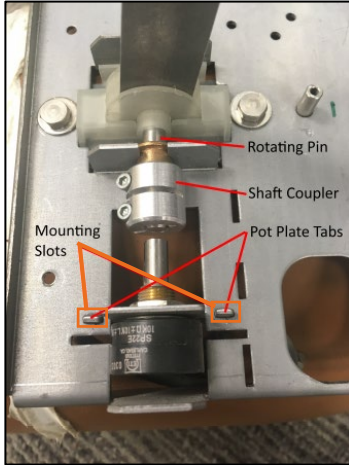

STEP 1

Loosen the shaft coupler by loosening the two hex screws. Slide the shaft coupler onto the rotating pin. Twist the potentiometer plate tabs until aligned with the base plate mounting slots.

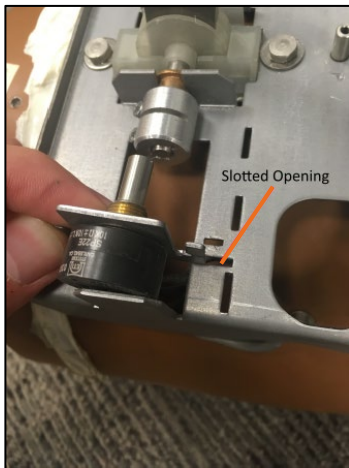

STEP 2

Slide the potentiometer plate down through the mounting slots, slide back and lift up through the large slotted opening.

NOTE: Discard the old potentiometer and shaft collar.

Using the new potentiometer replacement slide the potentiometer plate down through the large slotted opening in the base plate, slide forward and lift up through the mounting slots.

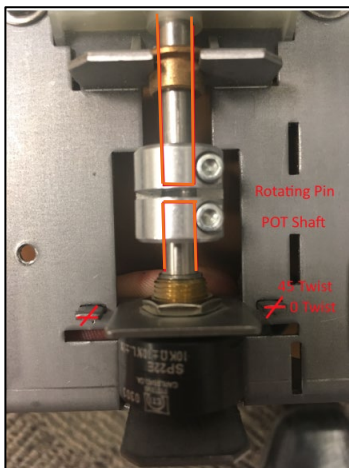

STEP 3

Twist the replacement potentiometer plate tabs until they're approximately twisted 30-45 degrees. This will fix the potentiometer plate in place.

NOTE: Do not exceed a 60-degree twist.



STEP 4

Align the control arm of the Venturi Valve so that it is straight vertical and verify that the potentiometer is at the center of its rotation. Do this by rotating the potentiometer (POT) shaft CW and then CCW to find its limits. Return the POT shaft to its center point, before proceeding to Step 5.

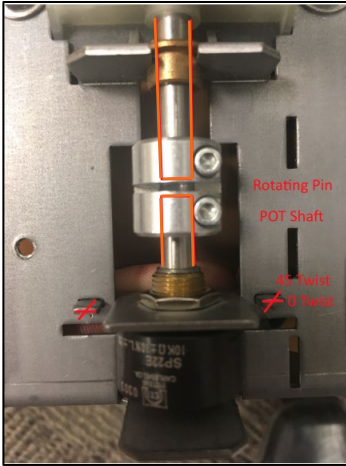

STEP 5

Slide the shaft coupler onto the POT & rotating pin, such that the coupler clamps onto each shaft as shown. Tighten the two hex screws.

STEP 6

Set the valve the minimum airflow position and rotate the POT until it matches the original POT curve for the valve.



CAUTION ▼

This step is intended to provide a rough initial position for the potentiometer. It may be necessary to rotate the potentiometer position after Step 7.

STEP 7

Move the valve control arm to verify that the POT, coupler and rotating pin do not slip. Route and connect POT wires to controller.

POT CURVE LABELS

This page can be printed to record the POT Curve Labels for all valves on the project if the old curves will not be available after the retrofit installation is completed.

| POT CURVE LABEL | | |
|-----------------|-----|------|
| ANTEC ORDER #: | | |
| POINT | CFM | VPOT |
| 1 | | |
| 2 | | |
| 3 | | |
| 4 | | |
| 5 | | |
| 6 | | |
| 7 | | |
| 8 | | |

| POT CURVE LABEL | | |
|-----------------|-----|------|
| ANTEC ORDER #: | | |
| POINT | CFM | VPOT |
| 1 | | |
| 2 | | |
| 3 | | |
| 4 | | |
| 5 | | |
| 6 | | |
| 7 | | |
| 8 | | |

| POT CURVE LABEL | | |
|-----------------|-----|------|
| ANTEC ORDER #: | | |
| POINT | CFM | VPOT |
| 1 | | |
| 2 | | |
| 3 | | |
| 4 | | |
| 5 | | |
| 6 | | |
| 7 | | |
| 8 | | |

| POT CURVE LABEL | | |
|-----------------|-----|------|
| ANTEC ORDER #: | | |
| POINT | CFM | VPOT |
| 1 | | |
| 2 | | |
| 3 | | |
| 4 | | |
| 5 | | |
| 6 | | |
| 7 | | |
| 8 | | |

| POT CURVE LABEL | | |
|-----------------|-----|------|
| ANTEC ORDER #: | | |
| POINT | CFM | VPOT |
| 1 | | |
| 2 | | |
| 3 | | |
| 4 | | |
| 5 | | |
| 6 | | |
| 7 | | |
| 8 | | |

| POT CURVE LABEL | | |
|-----------------|-----|------|
| ANTEC ORDER #: | | |
| POINT | CFM | VPOT |
| 1 | | |
| 2 | | |
| 3 | | |
| 4 | | |
| 5 | | |
| 6 | | |
| 7 | | |
| 8 | | |

BALANCING

The balancing process is required in the field to ensure that the valves are providing the necessary flow into and out of the pressure-controlled space. The process involves measuring the airflow through the valve in the field, using third party calibrated equipment and comparing it to the calibrated position feedback from the Venturi Valve.

Variable Volume Venturi Valve Retrofit (VVR)

There are two tools that are available in the Antec Controls system that will help adjust the calibrated position feedback from the Venturi Valve, they are scale factor and offset.

NOTE: When using PACE or CAVA controllers from Antec Controls, please refer to the appropriate manual for instructions on adjusting the settings described below.

Scale Factor

Scale factor is a multiplication factor that is applied to the controller's electronic flow feedback. Its default value is 1.000, which will not affect the flow feedback.

A scale factor greater than 1.000 will increase the flow feedback. A scale factor less than 1.000 will decrease the flow feedback. To determine the scale factor required simply use the following formula.

$$\text{Scale Factor} = \frac{\text{Balancer's Airflow Measurement}}{\text{Electronic Flow Feedback}}$$

NOTE: Scale factor is the recommended method of adjusting airflow readings.

Offset

Offset is an addition or subtraction in CFM, which is applied to the controller's electronic flow feedback. Its default value is 0 CFM, which will not affect the flow feedback.

$$\text{Offset} = \text{Balancer's Airflow Measurement} - \text{Electronic Airflow Feedback}$$

Recommended Balancing Procedure

Below are the recommended steps to take when balancing Venturi Valves.

1. Check to make sure the pressure across the Venturi Valves is within the operating range of the valve.
 - Note:** The minimum pressure drop will be indicated on the Specification label on the valve.
2. Depending on the balancer's process (which varies based on local requirements, balancer's test method, etc.), one of the following will be required:
 - a. One airflow will be measured. Typically, the Max Scheduled airflow for the valve.
 - b. Two airflows will be measured. Typically, the Max Scheduled and Min Scheduled airflow for the valve.
3. In both cases, it is preferable to only use a scale factor to modify the flow feedback from the valve.
4. If two airflows are measured and using only the scale factor cannot satisfy the requirements, a combination of scale factor and offset can be used.
5. If airflows cannot be easily balanced, it may be necessary to replace the potentiometer or create a new POT curve.



Adjustments should only be made after the differential pressure across the valve has been checked to ensure it is within the operating range of the valve.

TROUBLESHOOTING

| Symptom | Solution |
|--|--|
| Could not find a module on any COM Ports | Check the network settings on the fume hood controller. Ensure they are at default settings. |

Technical Support

If technical support is required, please contact us:

By Email: Applications@AntecControls.com

By Phone: 866.884.3524

Hours of Operation: Monday – Friday, 8:00 AM to 4:30 PM CST

NOTE: If you will need support outside of the above hours, please contact us 48 hours in advance.



Product Improvement is a continuing endeavour at Antec Controls by Price. Therefore, specifications are subject to change without notice. Consult your Sales Representative for current specifications or more detailed information. Not all products may be available in all geographic areas. All goods described in this document are warranted as described in the Limited Warranty. The complete product catalog can be viewed online at AntecControls.com © Antec Controls by Price is a registered trademark of Price Industries Limited. © 2022. Printed in Canada. v102