

# F-4300

## Clamp-On Ultrasonic Thermal Energy Measurement System Installation & Operation Addendum



## SAFETY INFORMATION

To ensure correct use of the system, please read this manual thoroughly.

Regarding this manual:

- This manual should be passed on to the end user.
- Before use, read this manual thoroughly to comprehend its contents.
- The contents of this manual may be changed without prior notice.
- All rights reserved. No part of this manual may be reproduced in any form without ONICON Incorporated's written permission.
- ONICON Incorporated makes no warranty of any kind with regard to this material, including, but not limited to, implied warranties of merchantability and suitability for a particular purpose.
- All reasonable effort has been made to ensure the accuracy of the contents of this manual. However, if any errors are found, please inform ONICON Incorporated.
- ONICON Incorporated assumes no responsibilities for this product except as stated in the warranty.
- If the customer or any third party is harmed by the use of this product, ONICON Incorporated assumes no responsibility for any such harm owing to any defects in the product which were not predictable, or for any indirect damages.

### SAFETY PRECAUTIONS:

The following general safety precautions must be observed during all phases of installation, operation, service, and repair of this product. Failure to comply with these precautions or with specific WARNINGS given elsewhere in this manual violates safety standards of design, manufacture, and intended use of the product. ONICON Incorporated assumes no liability for the customer's failure to comply with these requirements. If this product is used in a manner not specified in this manual, the protection provided by this product may be impaired.

The following messages are used in this manual:

#### **WARNING**

***Messages identified as "WARNING" contain information regarding the personal safety of individuals involved in the installation, operation or service of this product.***

#### **CAUTION**

***Messages identified as "CAUTION" contain information regarding potential damage to the product or other ancillary products.***

#### **IMPORTANT NOTE**

***Messages identified as "IMPORTANT NOTE" contain information critical to the proper operation of the product.***

**TABLE OF CONTENTS**

**SECTION 1.0 GENERAL INFORMATION .....4**

1.1 PRINCIPLE OF OPERATION .....4

1.2 TYPICAL F-4300 FLOW AND ENERGY METER.....4

1.3 MAINTENANCE.....5

1.4 ADDITIONAL HARDWARE THAT MAY BE REQUIRED .....5

**SECTION 2.0 MECHANICAL INSTALLATION .....6**

2.1 OVERVIEW.....6

2.2 THERMOWELL INSTALLATION FOR 0.25" DIAMETER SENSORS.....7

    2.2.1 Dry Tap Thermowells.....7

    2.2.2 Hot Tap Thermowells .....7

    2.2.3 ONICON Fixed Range / Loop Powered 4-20 mA Scalable Range Temperature Sensor Installation .....10

    2.2.4 Clamp-on Thermowell.....11

2.3 THERMOWELL INSTALLATION FOR 5 MM DIAMETER SENSORS.....13

2.4 THERMOWELL INSTALLATION FOR 6 MM DIAMETER SENSORS.....13

**SECTION 3.0 ELECTRICAL INSTALLATION.....14**

3.1 INPUT POWER REQUIREMENTS .....14

3.2 POWER AND OUTPUT SIGNAL WIRING CONNECTIONS.....15

3.3 BTU (ENERGY) METER INPUTS AND OUTPUTS WIRING CONNECTIONS .....16

3.4 TEMPERATURE SENSOR WIRING CONNECTIONS.....17

3.5 TEMPERATURE INPUTS WIRING DETAILS.....18

**SECTION 4.0 START-UP.....19**

4.1 NAVIGATING THE RUN MODE & PROGRAMMING PAGES .....19

4.2 RUN MODE & PROGRAMMING PAGE LAYOUT .....20

4.3 RUN MODE ICONS.....23

4.4 RUN MODE PAGES.....24

4.5 PROGRAMMING MODE PAGES .....26

**SECTION 5.0 BACNET MS/TP.....30**

5.1 BACNET PROTOCOL IMPLEMENTATION CONFORMANCE STATEMENT .....31

**SECTION 6.0 MODBUS RTU RS485 .....39**

6.1 MODBUS MEMORY MAP .....40

## SECTION 1.0 GENERAL INFORMATION

ONICON Incorporated would like to thank you for purchasing our quality F-4300 Clamp-on Ultrasonic Thermal Energy Measurement System. As our valued customer, our commitment to you is to provide fast reliable service, while continuing to offer quality products to meet your growing flow and energy measurement needs.

This addendum is intended to be used as supplement to the existing F-4300 Clamp-on Ultrasonic Flow Meter Installation & Operation Guide. It details the installation and operation of the meter's energy measurement functions.

### 1.1 PRINCIPLE OF OPERATION

The ONICON F-4300 Clamp-on Ultrasonic Thermal Energy Measurement System utilizes the differential transit time method to measure the velocity of relatively clean liquids in full pipes. By measuring the difference between transit times of ultrasonic sound waves traveling between two transducers, the flow velocity and direction are accurately determined. When provided with the energy measurement option, the F-4300 accepts additional sensor data from a matched pair of temperature sensors, performs a series of computations with the data, and displays and/or transmits the results as an indication of the amount of heat (BTUs) transferred per unit time or as a totaled amount.

### 1.2 TYPICAL F-4300 FLOW AND ENERGY METER

The F-4300 utilizes clamp-on signal transducers that are mounted on the outside wall of the pipe for measuring the volumetric flow of liquids in a wide variety of applications including bi-directional flow applications. Temperature sensors are installed on the supply and return lines leading to and from the heat exchange circuit. The meter is housed in a polycarbonate wall-mounted enclosure with a built-in user interface/display.

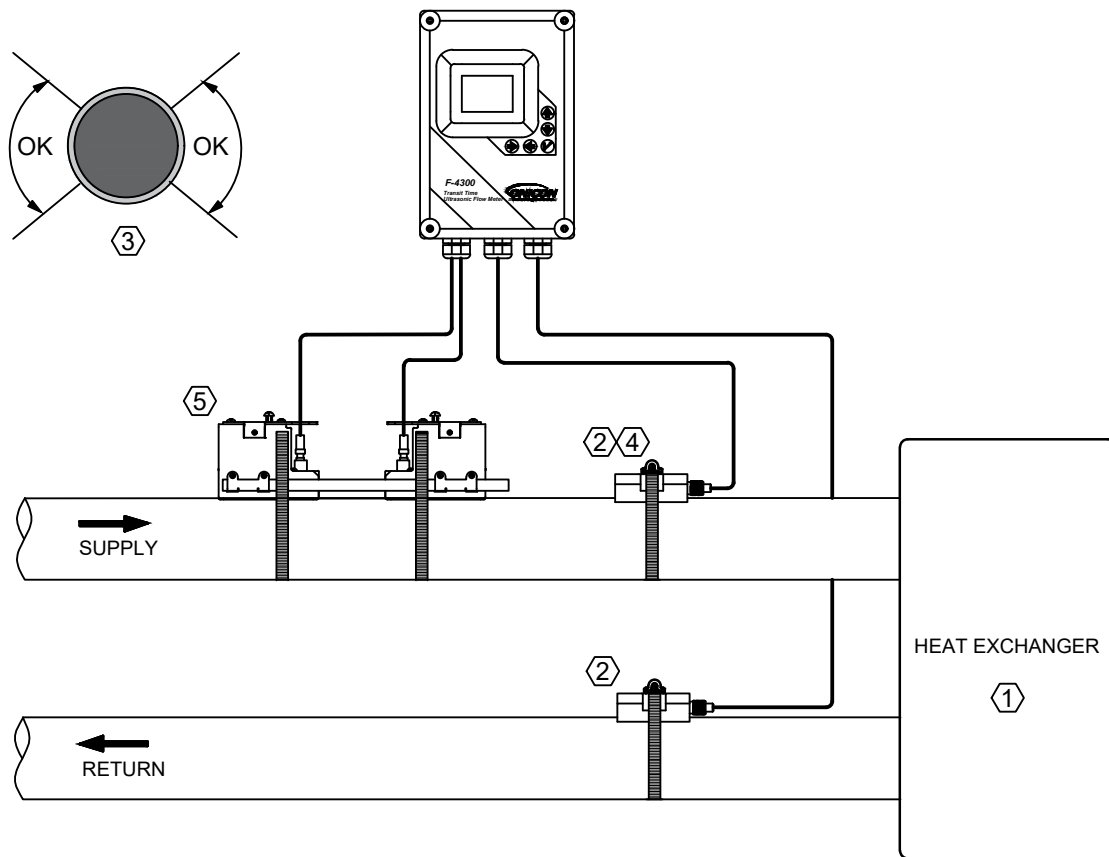

1. Flow and temperature sensors must only measure the fluid entering and leaving the heat exchanger.
2. Locate the temperature sensors near the heat exchanger whenever possible.
3. Immersion thermowells should be installed out of plane with ultrasonic flow transducers.
4. Located one sensor a minimum of 5 diameters downstream from the ultrasonic flow transducers.
5. The flow transducers can be installed on the supply or return line.

### **1.3 MAINTENANCE**

Periodically inspect the power cables, transducer cables, temperature sensor cables, cable glands and the enclosure for signs of damage. Inspect transducer installation and mounting hardware for loose connections or diminished ultrasonic couplant. Periodically inspect temperature sensors for loose connections and signs of damage.

### **1.4 ADDITIONAL HARDWARE THAT MAY BE REQUIRED**

Flex conduit may be required to connect transducer mounting brackets and/or temperature sensor enclosures to rigid conduit. Do not connect transducers mounting brackets or temperature sensors directly to rigid conduit.

## SECTION 2.0 MECHANICAL INSTALLATION

### 2.1 OVERVIEW

Information regarding the installation of ultrasonic transducers and the associated mounting hardware can be found in the F-4300 Clamp-on Ultrasonic Flow Meter Installation & Operation Guide.

The F-4300 energy measurement option combines flow data with data from a pair of temperature sensors in order to calculate energy. ONICON offers four different types of temperature sensor pairs and the associated thermowells for use with the F-4300.

#### CAUTION

**Temperature sensor thermowells must match the sensor diameter. Using the wrong diameter hardware will result in significant temperature measurement errors.**

Sensor Type	Sensor Diameter	Nominal Pipe Size Range (inches)
ONICON fixed range temperature sensor pair	0.25"	½ to 48"
100 Ω Platinum RTD pair, w/4-20mA transmitters	0.25"	½ to 48"
1000 Ω Platinum RTD pair, 4 wire	5mm	½ to 2½"
1000 Ω Platinum RTD pair, 4 wire	6mm	3 to 48"

The two temperature sensors must be located so they accurately measure only the temperature of the supply line entering and the return line leaving the portion of the piping system for which the energy measurement is being made.

If possible, find an easily accessible location where field wiring connections can be made from floor level. This will facilitate future service. Place the temperature sensors away from strong sources of electrical noise that might affect the performance of the sensors.

One temperature sensor thermowell will need to be placed in the same pipe with the flow meter. If it is an immersion thermowell, it must be located at least five (5) pipe diameters downstream of the flow meter leaving enough clearance to remove either sensor from the pipe without interference from the other sensor.

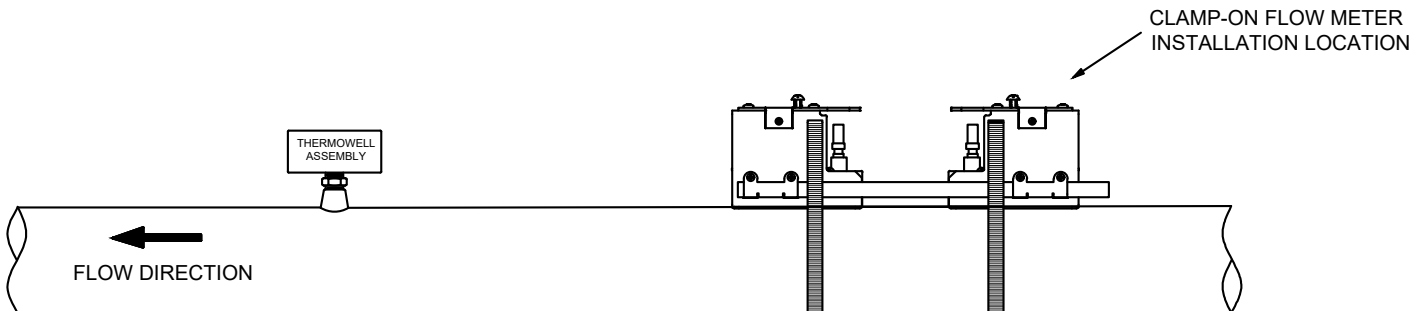

#### IMPORTANT NOTE

**When the F-4300 is ordered together with ONICON fixed range temperature sensor pairs, the meter is pre-programmed for use with the temperature sensors. Each sensor is labeled as the SUPPLY or RETURN sensor and must be installed according to these labels in order to match the F-4300 programming. RTDs are sold as matched pairs and are interchangeable between the supply and return pipes.**

## 2.2 THERMOWELL INSTALLATION FOR 0.25" DIAMETER SENSORS

### IMPORTANT NOTE

*It is important that no dirt or other foreign material be allowed into the thermowells as this could affect the thermal response of the system.*

### 2.2.1 Dry Tap Thermowells

Dry tap thermowells are for new construction or scheduled shutdown. The most common installation methods are shown below. Consult ONICON for special applications.

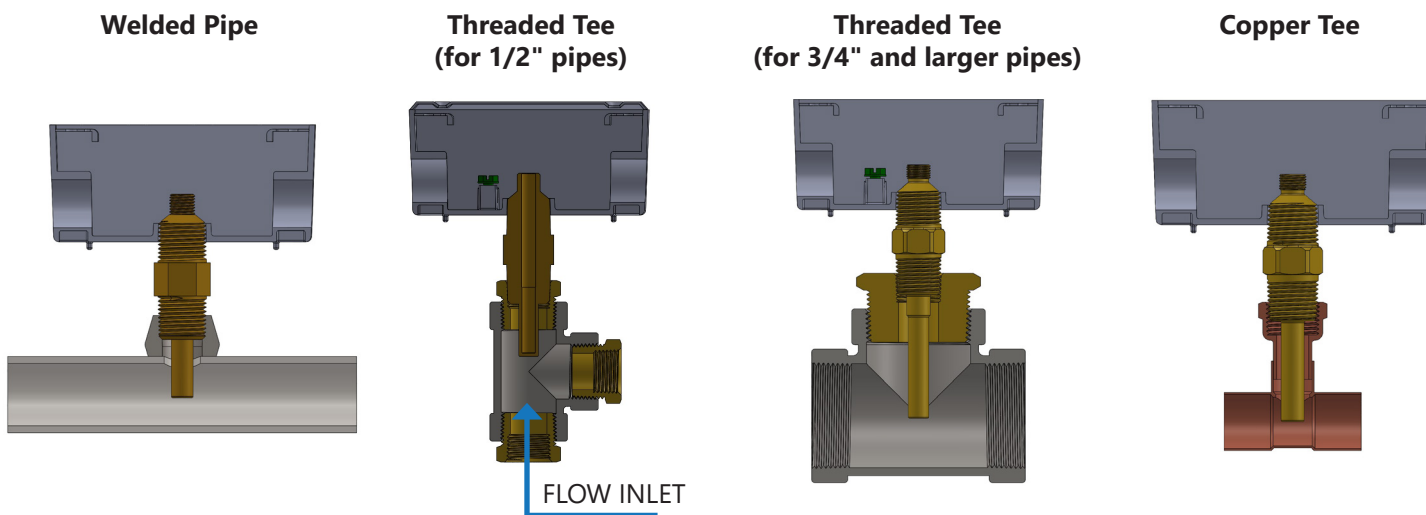

### NOTES

1. Thermowell length varies with pipe size.
2. Do not use multiple bushings to reduce the outlet size on threaded tees.

### 2.2.2 Hot Tap Thermowells

Hot tap thermowells are designed for retrofit applications where it is not practical to isolate and drain the pipe section prior to installation. The thermowell is installed through a 1" full port ball valve as shown in the drawing on next page. A hot tap drilling machine equipped with a 7/8" drill is required to perform this type of installation.

Install the valve assembly as shown in the drawing on the next page and then drill the 7/8" hole using the hot tap drilling machine. Once the valve assembly has been installed and the hole has been drilled, the thermowell can be inserted into the flow stream without a system shutdown.

### WARNING

**SYSTEM MAY BE UNDER HIGH PRESSURE. Be sure to hold the conduit box firmly by hand before slowly loosening the position clamping nut when installing, adjusting or removing the thermowell. Failure to do this will allow the pressure to suddenly and rapidly force the thermowell from the pipe, potentially causing serious injury. The thermowell could also be damaged or break apart causing a break in the water seal with the resultant loss of large amounts of water.**

2.2.2 Hot Tap Thermowells (Continued)

Insertion of the Hot Tap Thermowell

1. Calculate the insertion force (lbs) required by multiplying the system pressure (psig) by 0.11. The person inserting the thermowell should ensure adequate footing for the force required prior to opening the valve.
2. Thread the hot tap adapter into the valve. Firmly grasp the wiring enclosure, loosen the position clamping nut, open the valve, and carefully push the thermowell into the flow stream. Use the attached gage to set the insertion depth.

**CAUTION**

**Excessive vibration can damage the thermowell. Insert the thermowell to the proper depth using gauge supplied as shown. Reduce the insertion depth as necessary if strong vibrations are felt during insertion, making certain that the tip of the thermowell remains fully in the flow stream.**

3. Carefully tighten the position clamping nut that is located at the top of the 1" NPT hot tap adapter fitting. DO NOT release the wiring enclosure until the position clamping nut has been tightened.

**CAUTION**

**DO NOT OVER TIGHTEN THE POSITION CLAMPING NUT. If fluid leaks, do not attempt to correct by tightening this nut further. An internal o-ring seals the fluid. Contact ONICON for assistance in the event of a leak.**

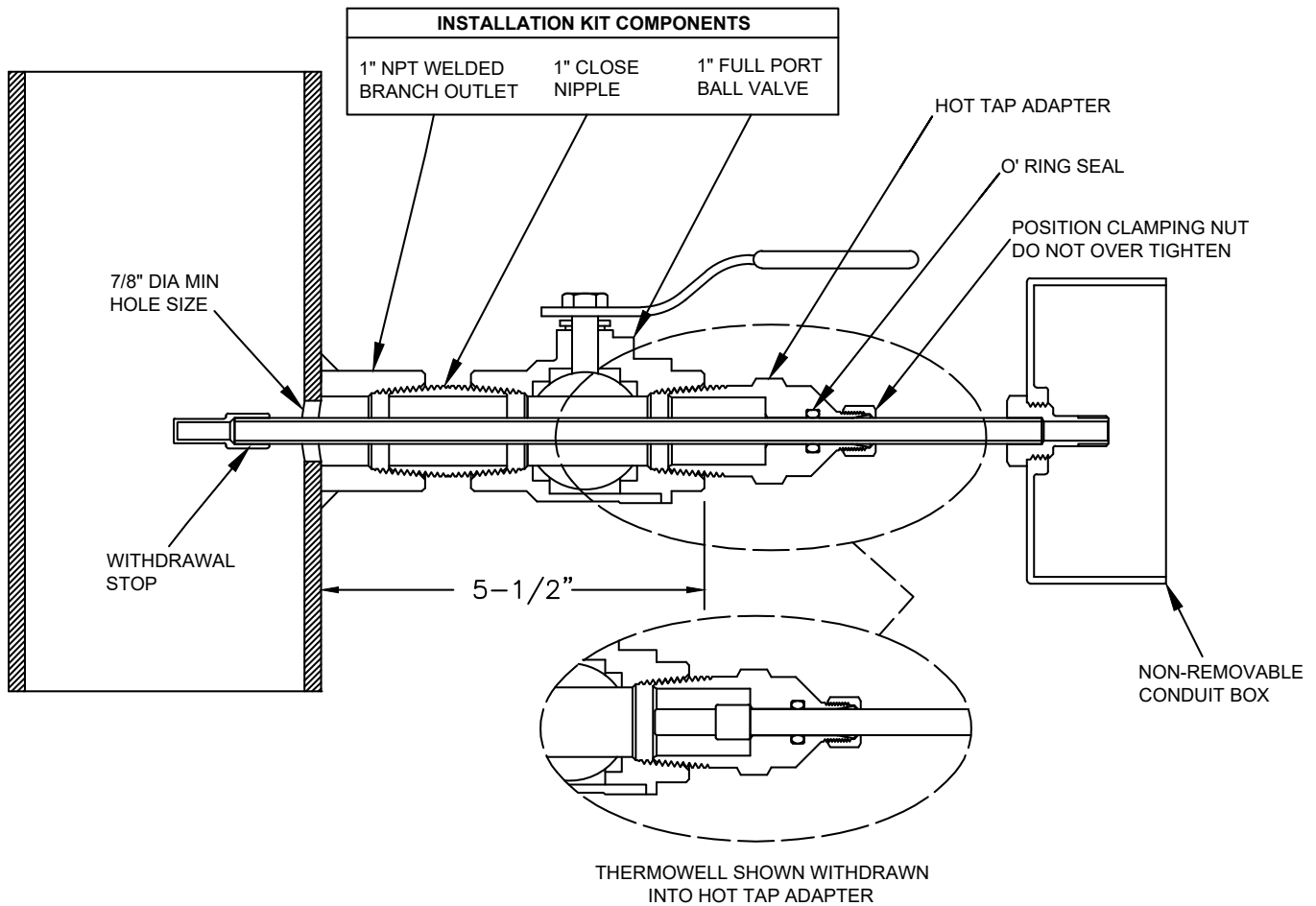

Hot Tap Installation Detail For Thermowell In Welded Pipe



## 2.2.2 Hot Tap Thermowells (Continued)

### Removal Of The Hot Tap Thermowell

#### **WARNING**

***Maintain a firm hold on the wiring enclosure until the thermowell is completely withdrawn and the valve is closed.***

1. System pressure will try to push the thermowell out of the flow stream when the clamping nut is released. Be sure to establish safe footing prior to loosening the clamping nut. The force pushing out against the thermowell is the same as the insertion force calculated above.
2. Grasp the wiring enclosure firmly, holding the thermowell in the pipe and then loosen the position clamping nut. Slowly withdraw the thermowell from the pipe. After the thermowell is completely withdrawn, carefully close the isolation valve.

#### **IMPORTANT NOTE**

***Rotating the thermowell as you slowly withdraw it through the valve will ensure that the lower tip is fully withdrawn and completely free of the valve. If resistance is felt when closing the valve, open valve fully and rotate the well as you pull it further out of the pipe.***

**2.2.3 ONICON Fixed Range / Loop Powered 4-20 mA Scalable Range Temperature Sensor Installation**

When ONICON fixed range or 4-20 mA scalable range temperature sensors are ordered with an F-4300, the meter is pre-programmed for these sensors. The sensors are also designated as the SUPPLY or RETURN sensor and must be installed accordingly.

To install, apply a thin coat of thermal compound to the tip area and insert the sensor all the way into the thermowell until it contacts the bottom of the well. Gently tighten the retainer nut. **DO NOT OVERTIGHTEN THIS NUT.** The only purpose for the nut is to ensure that the sensor tip remains in contact with the bottom of the thermowell.

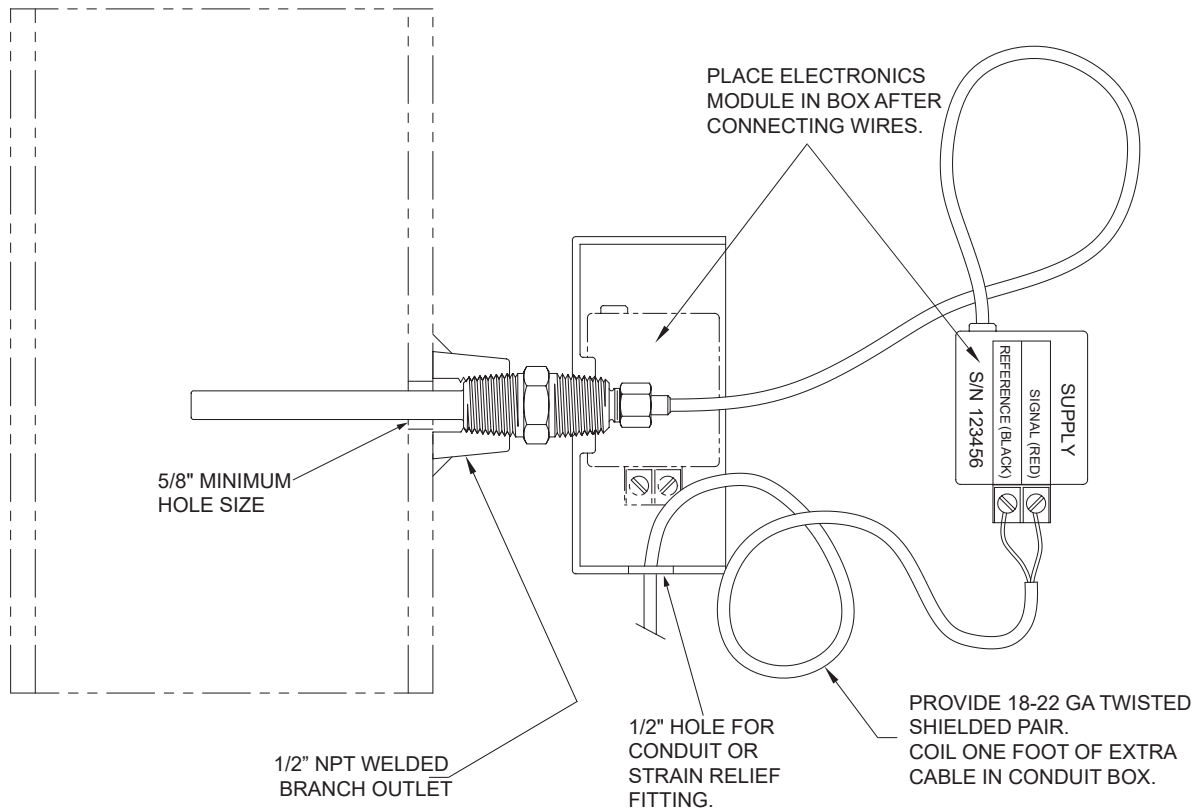
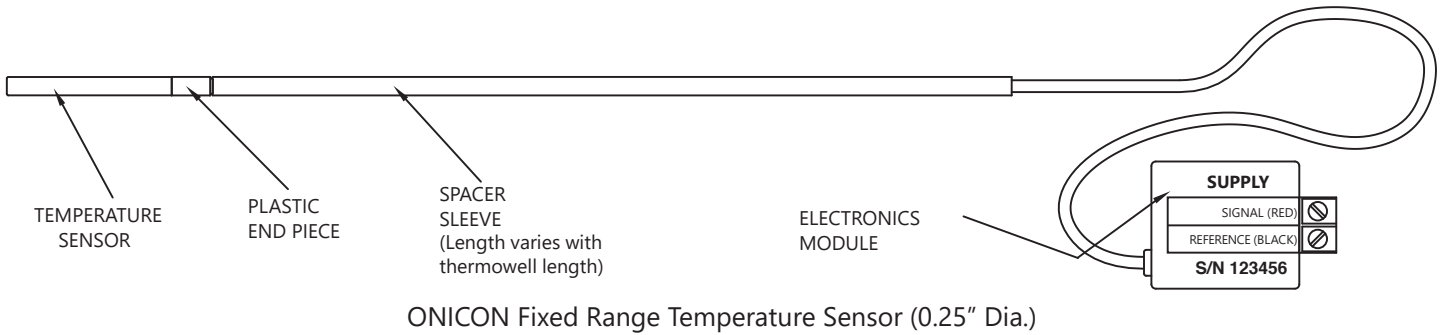

**CAUTION**

**DONOT OVERTIGHTEN. The thermowell completely seals the plumbing system. Screwing in the sensor just ensures that the sensor tip will remain in contact with the bottom of the thermowell.**

### 2.2.4 Clamp-on Thermowell

The two clamp-on temperature sensors must be located such that they only measure the temperature of the supply pipe entering and the return pipe leaving the portion of the piping system for which the energy measurement is being made. Once installed, the pipes and clamp-on thermowells must be fully insulated.

#### Inserting of the Clamp-on Thermowell

1. Remove junction box cover and set aside.

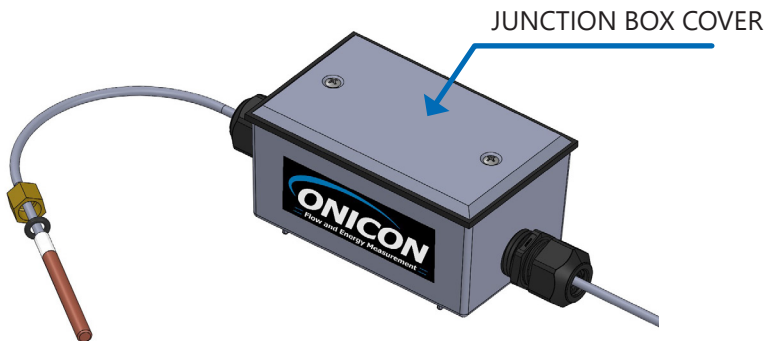

2. Attach the provided Velcro or the enclosure mounting hardware in the desired location as shown below.



3. Apply a thin coat of thermal compound to the temperature sensor, and gently insert the temperature sensor all the way into the clamp-on thermowell. Ensure the end of the temperature sensor is fully coated. DO NOT overtighten sensor.



**Inserting of the Clamp-on Thermowell (continued)**

4. Apply thermal compound to the heat sink and install the clamp-on thermowell on to the pipe using the pipe strap as shown.

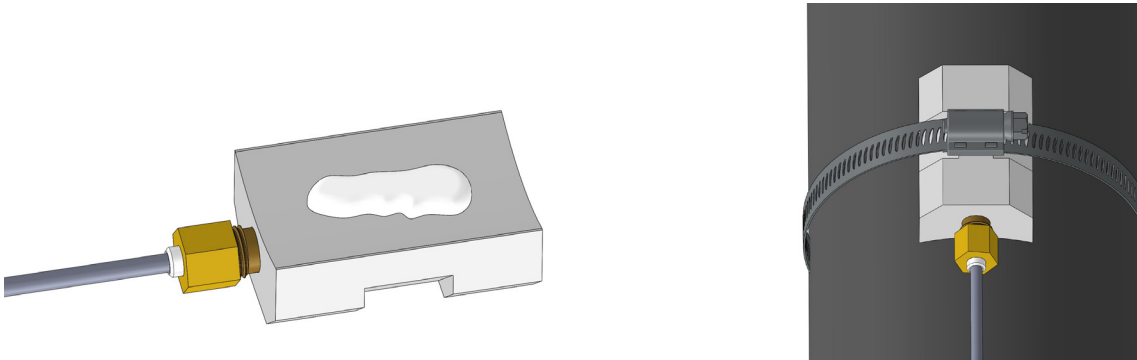

5. Connect the Signal (+) and Reference (-) wires from the transmitter to the F-4300 BTU meter through the strain relief. Be sure to observe the polarity of the connection, positive to positive and negative to negative. Shield wires should be connected at the F-4300, but left open at the temperature sensor transmitter.

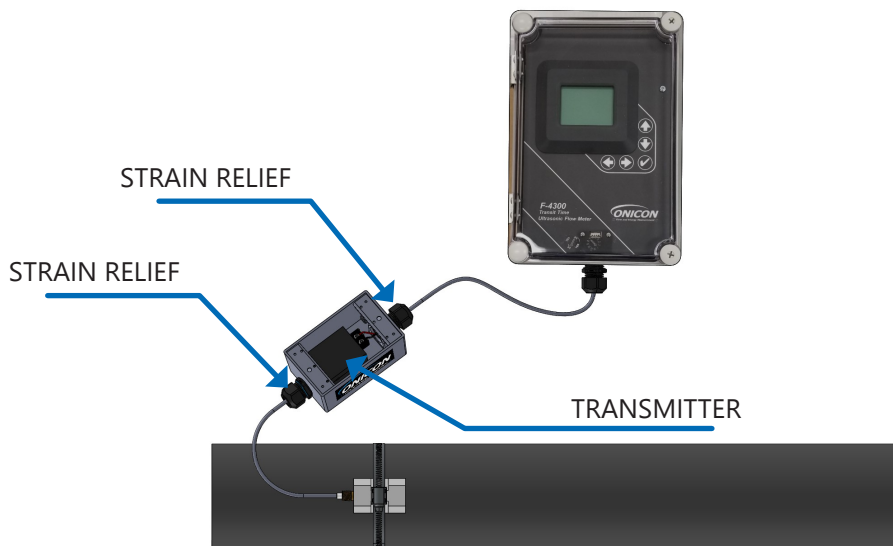

6. Tighten the strain reliefs and reinstall the junction box cover. Once the thermowells and sensors are fully installed and tested, insulate the thermowells and the pipe to complete the installation.

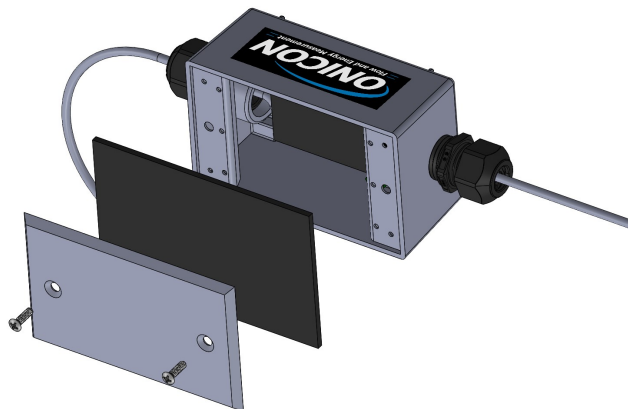

**2.3 THERMOWELL INSTALLATION FOR 5 MM DIAMETER SENSORS**

5 mm RTDs are provided with thermowells with 1/2" male NPT process connections. They are designed for use in 1/2" to 2 1/2" line size tees provided by the customer. The RTDs are push-in type and are held in place with a set screw. Depending on the pipe material, the kit may include a copper sweat bushing or a threaded reducer bushing.

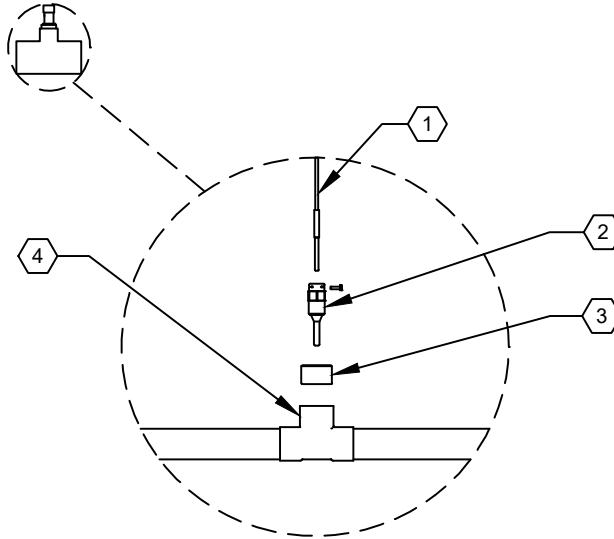

- 1. RTD temperature sensor – provided by ONICON.
- 2. 5 mm diameter thermowell – provided by ONICON.
- 3. 1" solder x 1/2" NPT bushing OR line size x 1/2" bushing – provided by customer or ordered from ONICON.
- 4. Customer supplied line size tee.

**2.4 THERMOWELL INSTALLATION FOR 6 MM DIAMETER SENSORS**

6mm RTDs are provided with matching length thermowells with 1/2" male NPT process connections. They are designed for use in 3" and larger diameter pipes. The RTDs are push-in type and are held in place with a set screw. The kit includes two (2) weld-on branch outlets with 1/2" NPT threads.

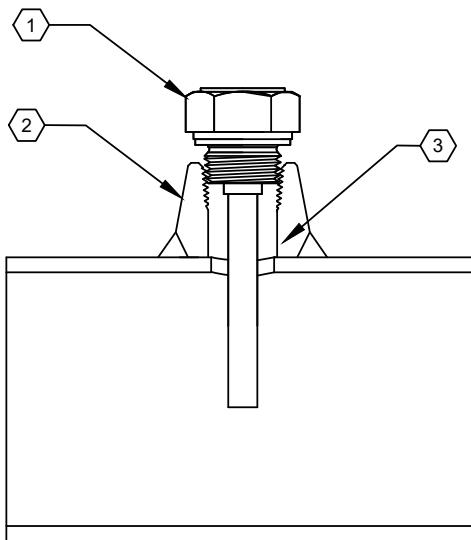

- 1. 6 mm diameter thermowell - provided by ONICON.
- 2. 1/2" NPT weld on branch outlet - provided by ONICON.
- 3. 3/4" minimum hole size.

## SECTION 3.0 ELECTRICAL INSTALLATION

All user supplied conduit fittings, junction boxes, etc. must be installed in compliance with federal, state, and local building codes.

### 3.1 INPUT POWER REQUIREMENTS

The F-4300 can be ordered with two different input voltage options. The input power options are:

- 24 V AC/DC, 50/60 Hz, 10 VA max
- 110-240 VAC, 50/60 Hz, 10 VA max

#### **WARNING**

*Conduit openings in the F-4300 enclosure must be closed with UL listed fittings applicable to NEMA 4X enclosures.*

#### **WARNING**

*The protective earth connection must be made as shown in Section 3.2. Failure to do so will result in an increased risk of injury.*

#### **WARNING**

*All mains voltage connections must be made through the pre-drilled conduit/strain relief opening located at the bottom of the enclosure. Failure to do so will result in an increased risk of injury.*

#### **CAUTION**

*This product must be connected to earth ground for proper operation. Failure to do so may result in erratic operation.*

Refer to F-4300 Clamp-on Ultrasonic Flow Meter IOM for more details on Electronic Installation.

3.2 POWER AND OUTPUT SIGNAL WIRING CONNECTIONS

**WARNING**

Turn off mains power at the source prior to making power connections to the F-4300. Contact with exposed live wiring may result in electric shock, burns and/or serious injury.

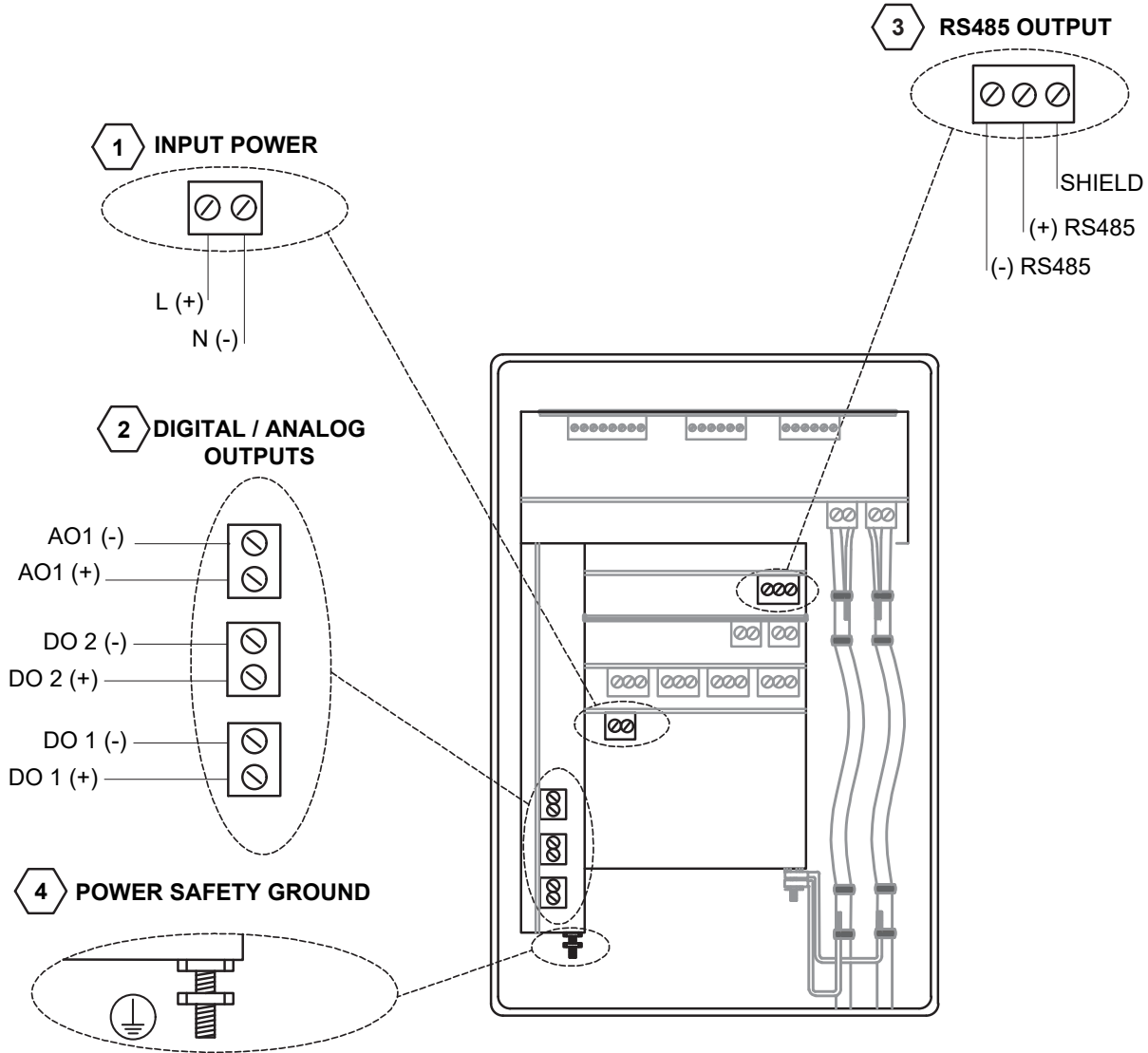

1. Input power

- 24 VAC/ VDC, 10 VA max OR
- 110-240 VAC, 50/ 60 Hz, 10 VA max

2. Output configuration

Two (2) programmable digital outputs and one (1) active analog output, 4-20 mA or 0-5 VDC (Menu selectable)

3. RS485 BACnet MS/TP or MODBUS RTU

4. Power safety ground connection

3.3 BTU (ENERGY) METER INPUTS AND OUTPUTS WIRING CONNECTIONS

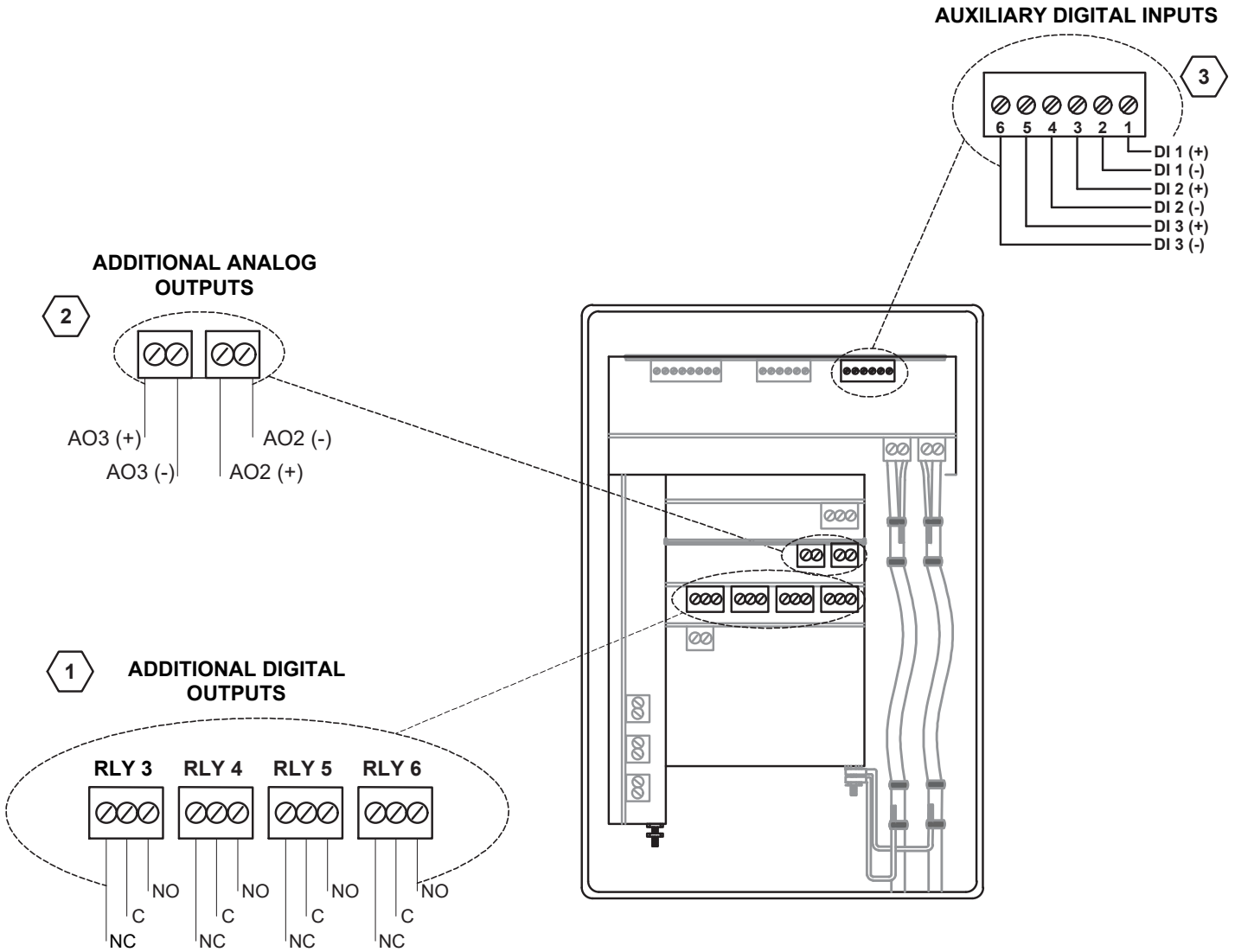

1. Configurable digital outputs terminal block connections
2. Configurable analog outputs terminal block connections (4-20 mA)
3. Configurable digital inputs terminal block connections



3.4 TEMPERATURE SENSOR WIRING CONNECTIONS

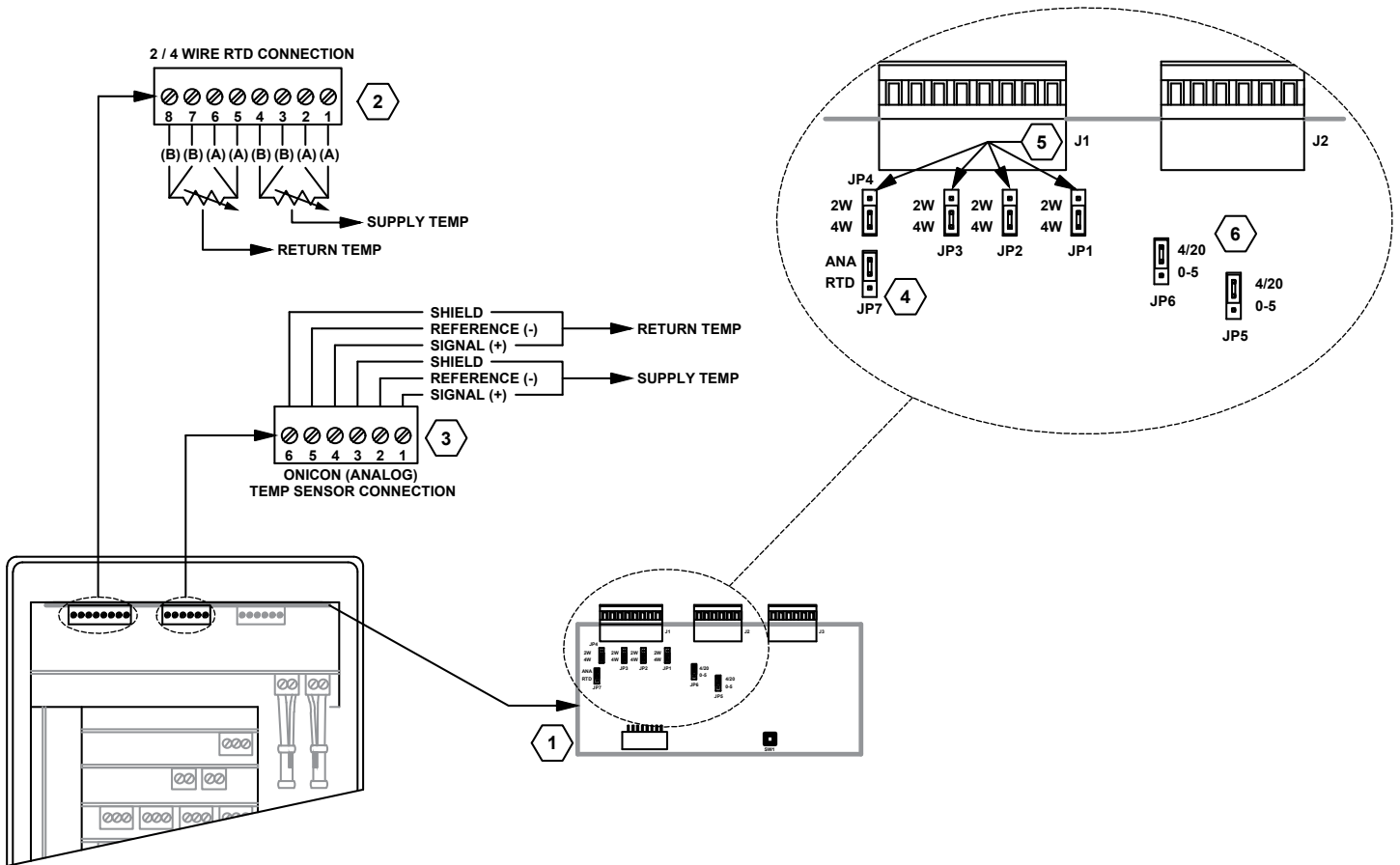

1. Energy computer circuit board.
2. 2 wire / 4 wire RTD connection terminal block.
3. ONICON temperature sensor connection terminal block.
4. Temperature sensor type selection jumper, JP7.
5. RTD type jumper selection, JP1 through JP4. Selects 2 wire vs 4 wire RTD input.
6. ONICON temperature sensor type selection jumpers, JP5 and JP6, 4-20 mA passive input or 0-5 VDC.

### 3.5 TEMPERATURE INPUTS WIRING DETAILS

#### ONICON FIXED RANGE or LOOP POWERED 4-20mA SCALABLE RANGE TEMPERATURE INPUTS

##### ONICON (ANALOG) TEMP SENSOR CONNECTION

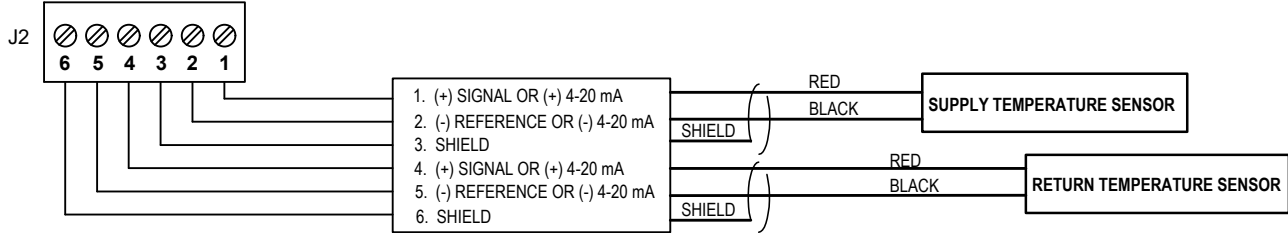

#### 1000 OHMS 4-WIRE PLATINUM RTD TEMPERATURE INPUTS w/ ATTACHED PIGTAIL CABLE

##### 2 / 4 WIRE RTD CONNECTION

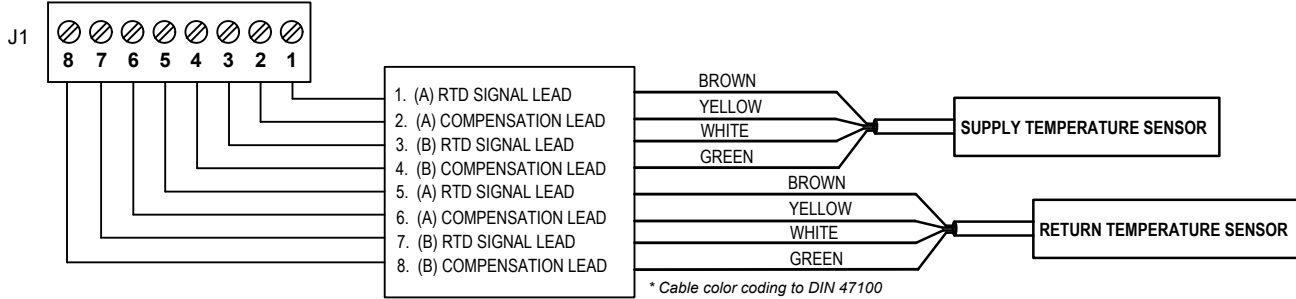

#### 1000 OHMS 4-WIRE PLATINUM RTD TEMPERATURE INPUTS w/ INTEGRAL CONDUIT READY JUNCTION BOX

##### 2 / 4 WIRE RTD CONNECTION

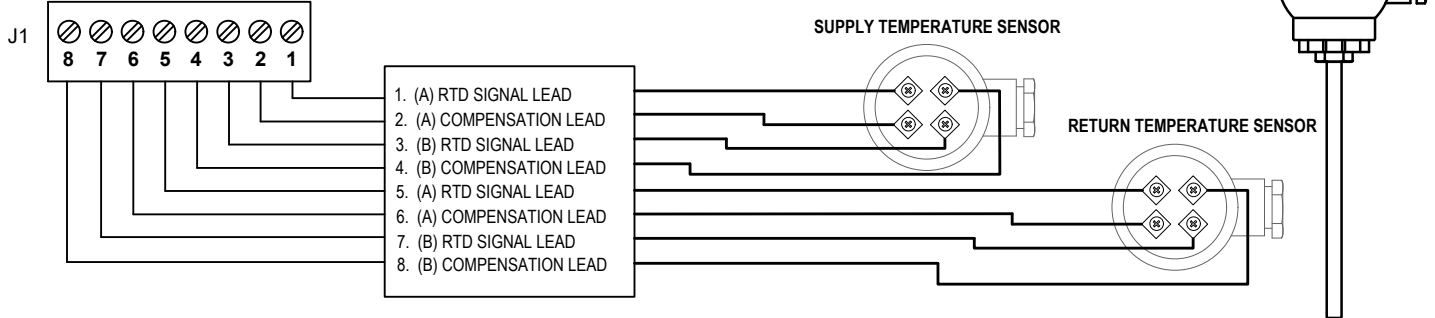

Refer to Serial Communication Wiring Connections on page 17 for additional details on the terminal location.

## SECTION 4.0 START-UP

ONICON F-4300 Clamp-on Ultrasonic Thermal Energy Measurement Systems are normally shipped with the intended installation parameters pre-programmed into the memory of the meter. This pre-programmed site is based on installation data provided to ONICON when the meter was ordered. The information programmed into the meter is also provided in a document that accompanies the installation hardware titled Site Installation Details.

Confirm that the Site Installation Details document matches the specific installation location. If there is any discrepancy between programmed parameters and actual site conditions, then the programming for the site must be edited before it is used. This manual contains information on programming the meter. Please contact ONICON if you require any assistance.

### 4.1 NAVIGATING THE RUN MODE & PROGRAMMING PAGES

The diagram on the next page shows the F-4300 menu system. Arrows show the four directions to navigate between menu boxes. Pressing a corresponding keypad arrow will move to the next item in the direction shown.

Move the cursor (highlighted) under numerals with the ← and → keys.

Increase or decrease numerals with the ↑ and ↓ keys.

Programming values are stored permanently after pressing the ✓.



Run Mode View

4.2 RUN MODE & PROGRAMMING PAGE LAYOUT

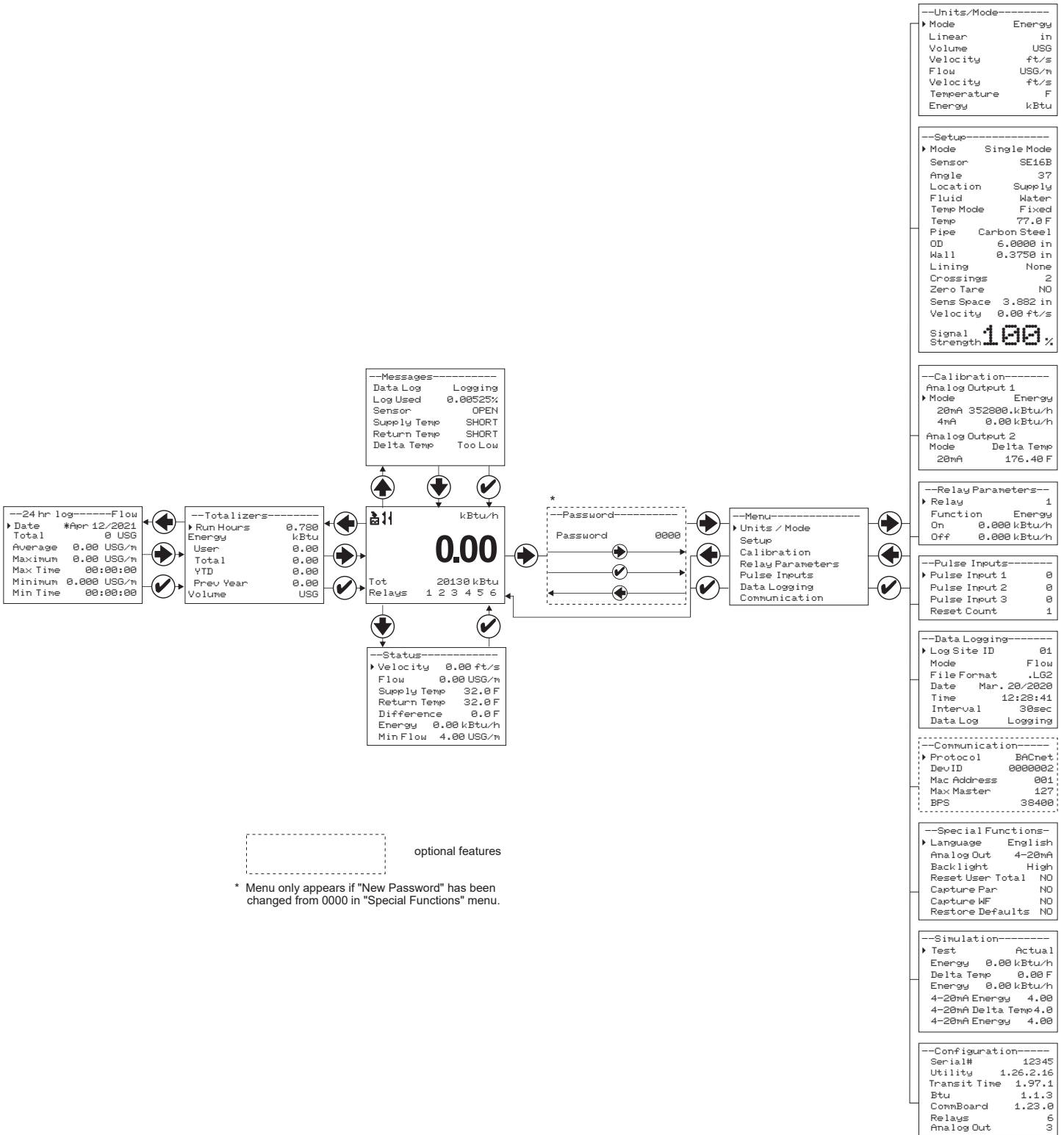

4.2 RUN MODE & PROGRAMMING PAGE LAYOUT (CONTINUED)

Program settings that affect energy measurement are shown in **bold italic** and are described on the following pages. Please refer to the F-4300 Clamp-on Ultrasonic Flow Meter Installation & Operation Guide for information on the other program settings.

Units / Mode	
<b>Mode</b>	<b>Energy</b>
Linear	In
Volume	USG
Multiplier	X1
Decimals	0
Velocity	ft/s
Flow	USG/m
Temperature	F
<b>Energy</b>	<b>kBtu</b>
<b>Multiplier</b>	<b>X1</b>
<b>Decimals</b>	<b>0</b>
<b>Power</b>	<b>kBtu/h</b>
<b>Decimals</b>	<b>0</b>

Setup	
<b>Mode</b>	<b>Single Mode</b>
Sensor	SE16B
Angle	37
<b>Location</b>	<b>Supply</b>
Fluid	Water
Temp Mode	Fixed
Temp	25.0 C
Pipe	PVC
OD	4.5000 in
Wall	0.2500 in
Lining	None
Crossings	2
Zero Tare	NO
Sens Space	0.335 in
Velocity	0.00 ft/s
Signal Strength	0%

Calibration	
<b>Analog Output 1</b>	
Mode	Energy
20mA	1000 kBtu/h
<b>4mA</b>	<b>0.00 kBtu/h</b>
<b>Analog Output 2</b>	
Mode	Flow
20mA	500 USG/m
4mA	0.00 USG/m
<b>Analog Output 3</b>	
Mode	Delta Temp
20mA	98.00 F
4mA	0.00 F
LOS Time	10 sec
Min Flow	0.88 USG/m
Damping	
Mode	FIR
Percent	10%
Window	1.0 ft/s
Cal Constant	1.000
<b>Supply Temp</b>	
Type	ONICON
<b>Return Temp</b>	
Type	ONICON

4.2 RUN MODE & PROGRAMMING PAGE LAYOUT (CONTINUED)

Relay Parameter	
Relay	1
<b>Function</b>	<b>Energy</b>
<b>On</b>	<b>1000 kBtu/h</b>
<b>Off</b>	<b>0.000 kBtu/h</b>

Pulse Inputs	
Pulse Input 1	0
Pulse Input 2	0
Pulse Input 3	0
Reset Count	1

Data Logging	
Log Site ID	01
<b>Mode</b>	<b>Energy</b>
File Format	LG2
Date	Jan 22/2020
Time	14:24:00
Interval	30sec
Data Log	Logging

















Communications	
Protocol	BACnet
Dev ID	0000001
MAC Address	001
Max Master	127
BPS	9600

Special Functions	
Language	English
Analog Out	4-20mA
Backlight	High
Reset User Total	NO
Rev. Flow	Off
Capture Par	NO
Capture WF	NO
Restore Defaults	NO
New Password	0000

Simulation	
Test	Actual
Flow	0.00 USG/m
Delta Temp	0.37 F
Energy	0.00 kBtu/h
4-20mA Flow	4.00
4-20mA Delta Temp	4.0
4-20mA Energy	4.00
Relays	1 2

Configuration	
Serial #	12345
Utility	1.26.1.3
TransitTime	1.1.3
Btu	1.1.3
CommBoard	1.22.6
Relays	2
Analog Out	3
4-20mA Energy	4.00
Relays	1 2

4.3 RUN MODE ICONS

ICONS	DESCRIPTION
 1.  2.	Message waiting. Press  to view message.
	Data logging off.
 1.  2.	Data logging on.
 1.  2.  3.  4.	USB file download.
	File download complete.
	Download error.
 1.  2.  3.	Ultrasonic echo established.
	No echo, empty pipe.
	No sensors attached / wrong settings.

4.4 RUN MODE PAGES

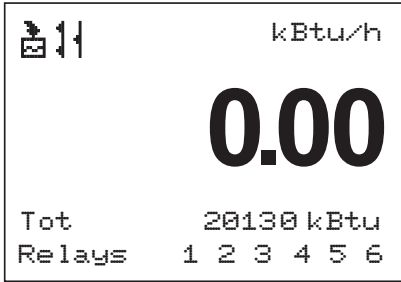

**Main Display Page** - The MAIN display shows the energy rate and totalizer in the units selected via the programming menu.

The bottom of the MAIN display shows the status of the pulse outputs. If any of the meter's pulse outputs are configured for totalization, the background of the specific pulse output programmed for this totalization will turn black, and then back to white after the pulse duration. If set for alarm, the background of the specific pulse output set for this alarm will turn black when latched on, and back to white when latched off.

The top-left corner of the MAIN display shows the status icons. Refer to the previous page for their descriptions. Energy meters configured for dual mode operation will also display the current operating mode at the top-center of the page.

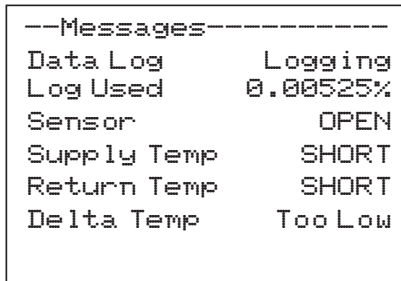

**Message Display Page** - Pressing  from the MAIN display will navigate you to the MESSAGE page.

On this page you can find the status of the logger and the % log used, along with the operating status for the flow sensors, supply temp sensor, return temp sensor and the delta temperature.

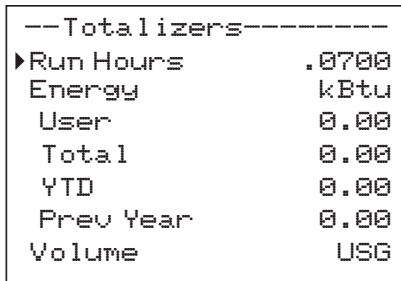

**Totalizers Display Page** - Pressing  once from the MAIN display will navigate you to the TOTALIZERS page.

On this page you can find run hour totals along with energy and volume totals.

Four different type of energy and volume totals are displayed:

- The User Totals are resettable.
- Total Energy and Total Volume are non-resettable grand totals.
- Year-to-date totals reset at the end of the calendar year and roll over to become the Previous Year Totals at the beginning of each new year.



4.4 RUN MODE PAGES (CONTINUED)

```

--24 hr log-----Flow
▶ Date      *Apr 12/2021
Total      0 USG
Average    0.00 USG/m
Maximum    0.00 USG/m
Max Time   00:00:00
Minimum    0.000 USG/m
Min Time   00:00:00
    
```

**24hr Log Display Page** - Pressing  twice from the MAIN display will navigate you to the 24 HR LOG page.

There are three (3) log pages, Flow, Delta T, and Energy. Each page shows data for the date indicated. By repeatedly pressing the down arrow, you can scroll back through the previous 365 days of data for each page.

The first log page displayed will be the flow page. This page will display total flow for the period along with the average, maximum and minimum values. The minimum and maximum values are time stamped.

```

--24 hr log-----Delta T
▶ Date      *Apr 12/2021
Average    0.00 F
Maximum    0.00 F
Max Time   00:00:00
Minimum    0.00 F
Min Time   00:00:00
    
```

Press the  again and the Delta T page will be displayed. This page provides average minimum and maximum temperatures with time stamps for minimum and maximum.

```

--24 hr log-----Energy
▶ Date      *Apr 12/2021
Total      0kBtu
Average    0.00 kBtu/h
Maximum    0.00 kBtu/h
Max Time   00:00:00
Minimum    0.00 kBtu/h
Min Time   00:00:00
    
```

Pressing the  a third time will display the Energy log page. This page will display total energy for the period along with the average, maximum and minimum values. The minimum and maximum values are time stamped.

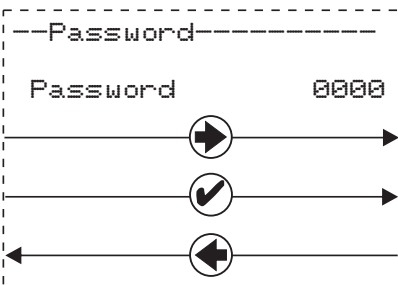

**Password Display Page** - Pressing the  from the MAIN display navigates you to the password entry page if the password has been changed from the default of 0000. This page comes before the programming menu, and is meant to allow you the ability to prevent malicious programming changes after deployment.

The password can be changed at any time by navigating into the programming menu and changing it. See section 4.5 for instructions on changing this value. If the password has been changed from the default, use the directional buttons to change the digit values, then the  to accept the password and move into the programming menu.

**4.5 PROGRAMMING MODE PAGES**

This manual provides programming information for settings that affect the F-4300 energy measurement option. Please refer to the F-4300 Clamp-on Ultrasonic Flow Meter Installation & Operation Guide for information on all other program settings.

For list selection options, press the **➡** at any option to select it, and the **⬆** or **⬇** to change the selection. Press **✓** to accept the change. For numeric entry options, press the **➡** to enter it, **➡** and **⬅** to navigate to different values, and then **⬆** or **⬇** to change the value selected. Press **✓** to accept the change.

```

--Units/Mode-----
▶Mode           Energy
Linear          in
Volume          USG
Velocity        ft/s
Flow            USG/m
Velocity        ft/s
Temperature     F
Energy          kBtu
    
```

**Units/Mode Menu Page**

The Units/Mode page allows the user to define whether the meter is configured to display energy, velocity, or flow rate, as well as define the engineering units seen on the MAIN display and programming menus.

**Mode** – Select between energy, flow or velocity for the main display reading.

Options: Energy, Flow or Velocity

**Energy** – Select Units for energy domain.

Options: KBtu, MBtu, Th (ton-hours), kJ, or MJ

**Multiplier** – Select multiplier to apply to energy units.

Options: x1, 10, 100, 1k, 10k, 100k, 1M, 10M or 100M

**Decimal**– Select the number of decimal points to be applied to energy units.

Options: 1, 2 or 3

**Power** – Select units for power domain.

Options: KBtu/h, T (tons), kW, or MW

**Decimal**– Select the number of decimal points to be applied to power units.

Options: 1, 2 or 3

4.5 PROGRAMMING MODE PAGES (CONTINUED)

```

--Setup-----
▶ Mode      Single Mode
  Sensor    SE16B
  Angle     37
  Location  Supply
  Fluid     Water
  Temp Mode Fixed
  Temp      77.0 F
  Pipe      Carbon Steel
  OD        6.0000 in
  Wall      0.3750 in
  Lining    None
  Crossings 2
  Zero Tare NO
  Sens Space 3.882 in
  Velocity  0.00 ft/s

Signal Strength 100%
    
```

**Setup Menu Page**

The Setup page allows the user to define the type of transducer used and to define process conditions like pipe material, size, fluid type and temperature. All of these settings are pre-configured by ONICON before shipment.

The mode setting defines the how energy is calculated. This setting is also pre-configured by ONICON before shipment and should only be adjusted if the process conditions provided to ONICON at time of order were incorrect. The location setting must be selected by the user at the time of installation.

**Mode** – Select between energy, flow or velocity for the main display reading.

Options: Energy, Flow or Velocity

**Location** – Identify which temperature sensor is installed in the same pipe with the flow sensors.

Options: Supply or Return

```

--Calibration-----
Analog Output 1
▶ Mode      Energy
  20mA     352800.kBtu/h
  4mA      0.00 kBtu/h

Analog Output 2
Mode      Delta Temp
20mA     176.40 F
    
```

**Calibration Menu Page**

The Calibration page allows the user to define the behavior of the flow measurement and the analog outputs. All of these settings are pre-configured by ONICON before shipment.

The analog output mode settings define the function for each output. These setting is also pre-configured by ONICON before shipment and should only be adjusted if the process conditions provided to ONICON at time of order were incorrect.

**Mode** – Select the function for analog outputs 1, 2 or 3

Options: Energy, Flow, Velocity, Supply Temp, Return Temp or Delta-T

4.5 PROGRAMMING MODE PAGES (CONTINUED)

```

--Relay Parameters--
▶ Relay          1
  Function      Energy
  On           0.000 kBtu/h
  Off          0.000 kBtu/h
    
```

**Relay Parameters Menu Page**

The Relay Parameter page allows the user to configure the pulse outputs available with the F-4300. All of these settings are pre-configured by ONICON before shipment and should only be adjusted if the process conditions provided to ONICON at time of order were incorrect.

**Relay** - Defines which pulse output you are making changes to.

Options: 1 through 6

**Function** – This setting defines the behavior of each relay output.

Options:

**On** – This forces the relay to remain in the normally closed state. It is used for diagnostic tests.

**Off** – This forces the relay to remain in the normally open state.

**Energy, Flow or Velocity** – These three functions configure the output as an alarm. When selected, you will be presented with additions settings for when the alarm turns on and off.

**Direction** – This configures the output as a flow direction switch.

ON = +0.1 GPM, OFF = -0.1 GPM

**Pulse** – This selection configures the output as a scaled pulse.

When selected, you will be presented with additions options for selecting the mode and the value of each pulse. Scaled pulses can be set for energy or flow.

```

--Pulse Inputs-----
▶ Pulse Input 1    0
  Pulse Input 2    0
  Pulse Input 3    0
  Reset Count      1
    
```

**Pulse Inputs Menu Page**

Totalizing pulse inputs display and transmit the total into the network. Each pulse is a count of an accumulated value from the F-4300 Thermal Energy Measurement System.

**Reset Count** – This option allows the user to reset the pulse counts to 1, 2 3 or All.

```

--Data Logging-----
▶ Log Site ID      01
  Mode             Flow
  File Format      .LG2
  Date            Mar. 20/2020
  Time            12:28:41
  Interval        30sec
  Data Log        Logging
    
```

**Data Logging Menu Page**

The Data Logging page allows configuration of the data logger. Options include what is being logged, how often it is being logged, and the date settings. Refer to the F-4300 Clamp-on Ultrasonic Flow Meter Installation & Operation Guide for additional information.

4.5 PROGRAMMING MODE PAGES (CONTINUED)

```

--Communication-----
▶ Protocol   BACnet
  DevID      0000002
  Mac Address 001
  Max Master 127
  BPS        38400
    
```

**Communication Menu Page**

The Communication page provides the means to select the serial output of the meter and the addressing and communications speed. Refer to the F-4300 Clamp-on Ultrasonic Flow Meter Installation & Operation Guide for additional information.

```

--Special Functions-
▶ Language   English
  Analog Out 4-20mA
  Backlight  High
  Reset User Total NO
  Capture Par NO
  Capture WF NO
  Restore Defaults NO
    
```

**Special Functions Menu Page**

The Special Functions page provides options for changing a variety of meter functions; such as the operating language and the brightness of the display. It also provides an option for resetting the User resettable totals.

**Reset User Total** – Simultaneously reset user energy and user volume totals.

Option: Set to YES. The display will flash and then return to NO to confirm that the totals have been reset.

```

--Simulation-----
▶ Test      Actual
  Energy    0.00 kBtu/h
  Delta Temp 0.00 F
  Energy    0.00 kBtu/h
  4-20mA Energy 4.00
  4-20mA Delta Temp 4.0
  4-20mA Energy 4.00
    
```

**Simulation Menu Page**

The Simulation page is used to generate flow, temperature, and energy output data independent of the actual measurement data. It is used to test the output signals. Refer to the F-4300 Clamp-on Ultrasonic Flow Meter Installation & Operation Guide for additional information.

```

--Configuration-----
  Serial#    12345
  Utility    1.26.2.16
  Transit Time 1.97.1
  Btu        1.1.3
  CommBoard  1.23.0
  Relays     6
  Analog Out 3
    
```

**Configuration Menu Page**

The Configuration page stores the serial number and meter configuration information for the F-4300. All values in this menu are read-only. Refer to the F-4300 Clamp-on Ultrasonic Flow Meter Installation & Operation Guide for additional information.

## SECTION 5.0 BACNET MS/TP

BACnet MS/TP, serial interface connections are connected at the RS485 card's terminal block.

Transceiver: 2-wire, half-duplex  
BACnet® address (MAC address) range: 1 - 247 (Default: 017)  
Device Instance: Baud rate: 0 - 4,194,302 (Default: 57017)  
9600, 19200, 38400 or 76800  
(Default: 38400)  
Termination: 120 ohms or none  
(Default: none)  
Jumper JP1 position 1 + 2 = OFF  
Jumper JP1 position 2 + 3 = ON  
Biasing: None  
Flow control: None

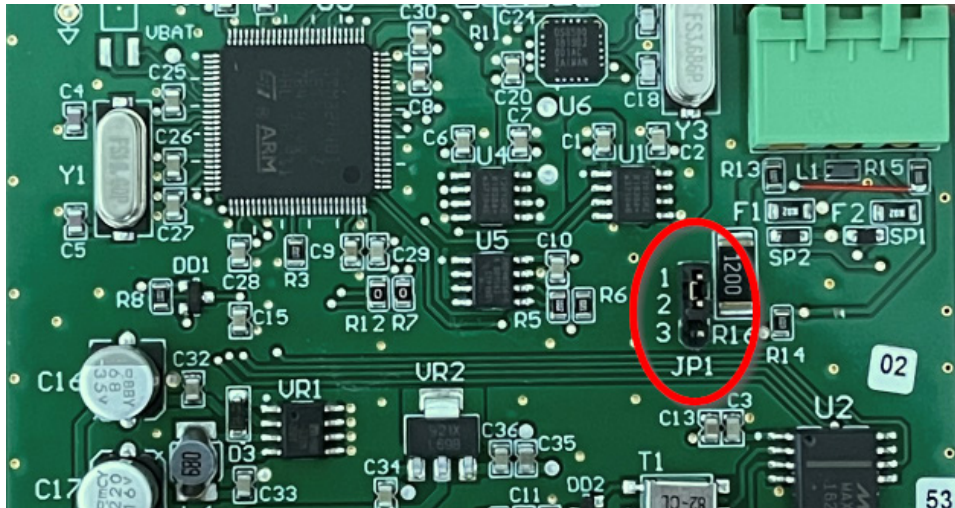

RS485 Output Card with Jumper JP1

**5.1 BACNET PROTOCOL IMPLEMENTATION CONFORMANCE STATEMENT**

<b>Application Software Version:</b>	1.26.2.14
<b>Firmware Revision:</b>	001.023.0
<b>BACnet Protocol Revision:</b>	10

**BACnet Standardized Device Profile (Annex L):**

BACnet Application Specific Controller (B-ASC)

**BACnet Interoperability Building Blocks Supported (Annex K):**

<b>DS-RP-B</b>	<b>DS-WP-B</b>	<b>DM-DDB-B</b>	<b>DM-DCC-B</b>	<b>DM-UTC-B</b>
<b>DS-RPM-B</b>	<b>DS-WPM-B</b>	<b>DM-DOB-B</b>	<b>DM-TS-B</b>	<b>T-VMMV-I-B</b>

**IMPORTANT NOTE**

*Device communications control (DM-DCC-B) password: ONICON INC*

**Segmentation Capability:** Not supported

**Standard Object Types Supported:** (See Tables 1 – 8 on the following pages for optional & writable properties)

All objects:

- CreateObject Service: Not supported
- DeleteObject Service: Not supported

**Data Link Layer Options:**

MS/TP master (Clause 9), baud rate(s): 9600, 19200, 38400 & 76800

**Device Address Binding:**

Is static device binding supported  Yes  No

**Networking Options:** Not supported

**Character Sets Supported:**

ISO 10646 (UTF-8)

**Gateway Options:** Not supported

**Network Security Options:**

Non-secure Device – is capable of operating without BACnet Network Security

Table 1.

<b>Device Object</b>			
<b>Property</b>	<b>Default Value</b>	<b>Writable</b>	<b>Comment</b>
Object Identifier	57017	Yes	0 – 4,194,303
Object Name	F-4300-XXXXXX	Yes	X = serial number
Object Type	Device	No	
System Status	Operational	No	
Vendor Name	ONICON Inc.	No	
Vendor Identifier	206	No	
Model Name	BTU Meter	No	
Firmware Revision	001.023.000	No	
Application Software Version	001.023.000	No	
Object List	(device, 1), (analog input, 1 – 10), (analog value, 1 – 24), (binary value, 1 – 10), (multi-state value, 1 – 3), (trendlog multiple, 1)	No	
Max ADPU Length	480	No	
Segmentation Supported	No Segmentation	No	
APDU Timeout	6000	Yes	
# of ADPU Retries	3	Yes	
Device Address Binding	{}	No	
Database Revision	1	No	
Property list		No	
<b>Optional Properties Supported</b>			
Description	Customer Description	Yes	32 char. max.
Local Time	Device current time	Yes	
Location	Customer location	Yes	32 char. max.
Local Date	Device current date	Yes	
UTC Offset	-300	Yes	
Daylight Savings Status	False	Yes	
Max Master	127	Yes	
Max Info Frames	1	No	



Table 2.

<b>Analog Input</b>			
<b>Property</b>	<b>Default Value</b>	<b>Writable</b>	<b>Comment</b>
Object Identifier	Analog Input 1 – 10	No	
Object Name	Various	Yes	
Object Type	Analog input	No	
Present Value	Real	No	See note 1.
Status Flags	F, F, F, F	No	
Event State	Normal	No	
Reliability	No-fault detected	No	
Out of Service	FALSE	No	
Units	Various	No	
Property List		No	
<b>Optional Properties Supported</b>			
Description	Analog-input #, Name	Yes	

Note 1. This property is commandable when the OUT\_OF\_SERVICE is true.

Table 2a.

<b>Object Identifier</b>	<b>Object Name</b>	<b>Description</b>
Ai 1	Energy Rate	Thermal energy (heat) flow rate
Ai 2	Flow Rate	Volume flow rate at the meter
Ai 3	Velocity	Velocity at the meter
Ai 4	Supply Temperature	Present value of the supply temperature sensor
Ai 5	Return Temperature	Present value of the return temperature sensor
Ai 6	Delta Temperature	Present value of temperature difference between sensors
Ai 7	Signal Strength	Flow transducer signal strength
Ai 8	Sonic Velocity	Speed of sound through the liquid
Ai 9	Peak Energy Rate	Peak energy value (trendlog value)
Ai 10	Average Delta Temp	Average delta temperature (trendlog value)

Table 3.

<b>Analog Value</b>			
<b>Property</b>	<b>Default Value</b>	<b>Writable</b>	<b>Comment</b>
Object Identifier	Analog Value 1 through 24	No	
Object Name	Various	Yes	
Present Value	Real	No	
Status Flags	F, F, F, F	No	
Event State	Normal	No	
Out of Service	FALSE	No	
Units	Various	No	
Property List		No	
<b>Optional Properties Supported</b>			
Description	Analog-value #, Name	Yes	
Priority Array	{NULL, NULL, NULL, NULL, NULL, NULL, NULL, NULL, NULL, NULL, NULL, NULL, NULL, NULL, NULL, NULL}	No	
Relinquish Default		No	

**Table 3a.**

<b>Object Identifier</b>	<b>Object Name</b>	<b>Description</b>
AV 1	Energy Total Mode 1	Mode 1 or single mode energy total
AV 2	Energy Total Mode 2	Mode 2 or single mode energy total
AV 3	YTD Energy Total Mode 1	Mode 1 or single mode YTD energy total
AV 4	YTD Energy Total Mode 2	Mode 2 or single mode YTD energy total
AV 5	PRV Energy Total Mode 1	Mode 1 or single mode prev. YR energy total
AV 6	PRV Energy Total Mode 2	Mode 2 or single mode prev. YR energy total
AV 7	User Energy Total Mode 1	Mode 1 or single mode user resettable total
AV 8	User Energy Total Mode 2	Mode 2 or single mode user resettable total
AV 9	Total Flow Mode 1	Mode 1 or single mode volume total
AV 10	Total Flow Mode 2	Mode 2 or single mode volume total
AV 11	Total Flow YTD Mode 1	Mode 1 or single mode YTD volume total
AV 12	Total Flow YTD Mode 2	Mode 2 or single mode YTD volume total
AV 13	Total User Flow YTD Mode 1	Mode 1 or single mode user resettable total
AV 14	Total User Flow YTD Mode 2	Mode 2 or single mode user resettable total
AV 15	Aux Input Pulse 1 Total	Total count of aux input 1 pulses
AV 16	Aux Input Pulse 2 Total	Total count of aux input 2 pulses
AV 17	Aux Input Pulse 3 Total	Total count of aux input 3 pulses
AV 18	Run Hours Odometer	Non-resettable total of run time in hours
AV 19	Total Flow PVY Mode 1	Mode 1 or single mode prev. YR volume total
AV 20	Total Flow PVY Mode 2	Mode 2 or single mode prev. YR volume total
AV 21	Incremental Energy Total Mode 1	Mode 1 or single mode trendlog total
AV22	Incremental Energy Total Mode 2	Mode 2 or single mode trendlog total
AV23	Incremental Volume Total Mode 1	Mode 1 or single mode trendlog total
AV24	Incremental Volume Total Mode 2	Mode 2 or single mode trendlog total

Table 4.

<b>Binary Value</b>			
<b>Property</b>	<b>Default Value</b>	<b>Writable</b>	<b>Comment</b>
Object Identifier	Binary Value 1 – 9	No	
Object Name	Various	Yes	
Present Value	0	Yes	
Status Flags	F, F, F, F	No	
Event State	Normal	No	
Out of Service	FALSE	No	
Property List		No	
<b>Optional Properties Supported</b>			
Description	Binary-Value #, Name	Yes	
Inactive Text	Various	No	
Active Text	Various	No	
Priority Array	{NULL, NULL, NULL, NULL, NULL, NULL, NULL, NULL, NULL, NULL, NULL, NULL, NULL, NULL, NULL, NULL}	Yes	
Relinquish Default		Yes	

Table 4a.

<b>Object Identifier</b>	<b>Object Name</b>	<b>Description</b>
BV 1	Mode	Mode status (mode 1 or 2)
BV 2	Flow Sensor Location	Supply or return pipe
BV 3	Reset User Total Energy Mode 2	Resets user energy total
BV 4	Reset User Total Energy Mode 1	Resets user energy total
BV 5	Reset User Total Volume Mode 1	Resets user volume total
BV 6	Reset User Total Volume Mode 2	Resets user volume total
BV 7	Reset Aux Input Count 1	Reset aux total 1
BV 8	Reset Aux Input Count 2	Reset aux total 2
BV 9	Reset Aux Input Count 3	Reset aux total 3
BV 10	Flow Direction	Indicates forward or reverse flow

Table 5.

<b>Multi-state Value</b>			
<b>Property</b>	<b>Default Value</b>	<b>Writable</b>	<b>Comment</b>
Object Identifier	Multi-state Value 1 – 3	No	
Object Name	Various	Yes	
Present Value	0	No	
Status Flags	F, F, F, F	No	
Event State	Normal	No	
Out of Service	FALSE	No	
Number of States	Varies	No	
Property List		No	
<b>Optional Properties Supported</b>			
Description	Multi-state-value #, Name	Yes	
State Text	Varies	No	

Table 5a.

<b>Object Identifier</b>	<b>Object Name</b>	<b>Description</b>
MSV 1	Flow Sensor Status	Indicates flow sensor status 0 – sensor good 1 – low signal 2 – sensor open 3 – sensor short 4 – sensor check calibration 5 – sensor relay fault 6 – sensor system fault
MSV 2	Logging Status	Indicates log status 0 – stopped 1 – active 2 – full
MSV 3	Temperature Sensor Status	Indicates temperature sensor status 0 – normal 1 – low supply temperature 2 – high supply temperature 3 – low return temperature 4 – high return temperature 5 – delta temperature < minimum 6 – high energy rate 7 – string

Table 6.

<b>Trendlog Multiple</b>			
<b>Property</b>	<b>Default Value</b>	<b>Writable</b>	<b>Comment</b>
Object Identifier	Trendlog Multiple-1	No	
Object Name	Log Data	No	
Object Type	Trendlog Multiple	No	
Description	Trendlog multiple #, Name	No	
Status Flags	F, F, F, F	No	
Event State	Normal	No	
Reliability	No-fault detected	No	
Enable	TRUE	Yes	
Log Device Property		No	
Logging Type	POLLED	No	
Log Interval	9000	Yes	
Stop When Full	FALSE	No	
Buffer Size	480	No	
Log Buffer		No	
Record Count	0	Yes	
Total Record Count	0	No	
<b>Optional Properties Supported</b>			
None			

Table 6a.

<b>Trendlog Multiple</b>		
<b>Object Identifier</b>	<b>Description</b>	<b>Note</b>
Trendlog Multiple 1	<p>Logs the following BACnet objects:</p> <ul style="list-style-type: none"> <li>Peak energy rate</li> <li>Average delta temp</li> <li>Incremental energy total mode 1</li> <li>Incremental energy total mode 2</li> <li>Incremental volume total mode 1</li> <li>Incremental volume total mode 2</li> <li>Meter status (multi-state object)</li> </ul>	<p>The log buffer holds 120 records and then rolls over with the first in as first out.</p> <p>The logging interval can be set from 30 seconds to 1 hour via BACnet. The default interval is 15 minutes.</p>

## SECTION 6.0 MODBUS RTU RS485

Transceiver:	2-wire, half-duplex
Data format:	8 Data Bits, 1 or 2 Stop Bits (Default: 1 Stop Bits)
Parity:	None, Odd, or Even (Default: Even)
MODBUS MAC address (device address) range:	1 - 255 (Default: 017)
Baud rate:	9600, 19200, 38400, or 76800 (Default: 38400)
Termination:	120 ohms or none (Default: none)
	Jumper JP1 position 1 + 2 = OFF
	Jumper JP1 position 2 + 3 = ON
Biasing:	None
Flow control:	None

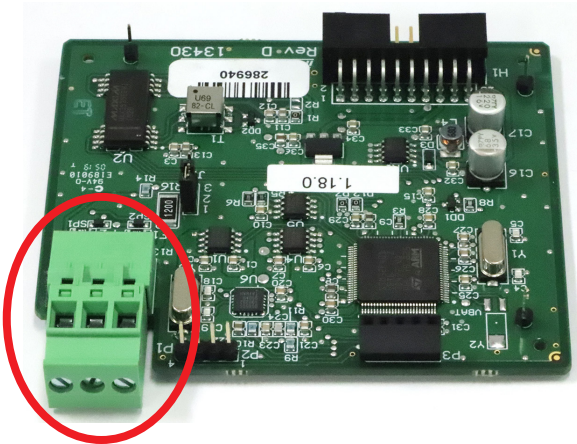

RS485 Output Terminal Block

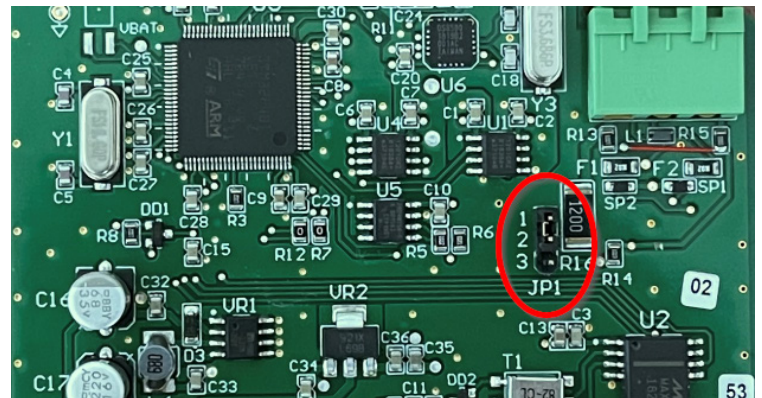

RS485 Output Card with Jumper JP1

6.1 MODBUS MEMORY MAP

Register Address	Description	Register Type	Data Range	Over Range	Read/Write	Comments
1	Reset Volume Total	Coil	NA	NA	Read/Write	Turn coil ON (1) to reset total. Turn coil to OFF (0)once reset is complete.
2	Reset User Energy Mode 1	Coil	NA	NA	Read/Write	Turn coil ON (1) to reset total. Turn coil to OFF (0)once reset is complete.
3	Reset User Energy Mode 2	Coil	NA	NA	Read/Write	Turn coil ON (1) to reset total. Turn coil to OFF (0)once reset is complete.
4	Reset User Volume Single Mode	Coil	NA	NA	Read/Write	Turn coil ON (1) to reset total. Turn coil to OFF (0)once reset is complete.
5	Reset User Volume Mode 1	Coil	NA	NA	Read/Write	Turn coil ON (1) to reset total. Turn coil to OFF (0)once reset is complete.
6	Reser User Volume Mode 2	Coil	NA	NA	Read/Write	Turn coil ON (1) to reset total. Turn coil to OFF (0)once reset is complete.
7	Reset Aux Input Count 1	Coil	NA	NA	Read/Write	Turn coil ON (1) to reset total. Turn coil to OFF (0)once reset is complete.
8	Reset Aux Input Count 2	Coil	NA	NA	Read/Write	Turn coil ON (1) to reset total. Turn coil to OFF (0)once reset is complete.
9	Reset Aux Input Count 3	Coil	NA	NA	Read/Write	Turn coil ON (1) to reset total. Turn coil to OFF (0)once reset is complete.
10	Reset Aux Input Count All	Coil	NA	NA	Read/Write	Turn coil ON (1) to reset total. Turn coil to OFF (0)once reset is complete.
8	Aux Output 1	Coil	NA	NA	Read/Write	Turn coil ON (1) to latch Pulse/Relay # 1 closed. Turn coil to OFF (0) to latch Pulse/Relay # 1 open. Pulse/Relay # 1 must have been programmed for "MODBUS Coil" in the commissioning menu.
9	Aux Output 2	Coil	NA	NA	Read/Write	Turn coil ON (1) to latch Pulse/Relay # 1 closed. Turn coil to OFF (0) to latch Pulse/Relay # 2 open. Pulse/Relay # 2 must have been programmed for "MODBUS Coil" in the commissioning menu.
10	Aux Output 3	Coil	NA	NA	Read/Write	Turn coil ON (1) to latch Pulse/Relay # 1 closed. Turn coil to OFF (0) to latch Pulse/Relay # 3 open. Pulse/Relay # 3 must have been programmed for "MODBUS Coil" in the commissioning menu.



6.1 MODBUS MEMORY MAP (CONTINUED)

Register Address	Description	Register Type	Data Range	Over Range	Read/Write	Comments
10001	Pulse/Relay Output 1 Status	Discreet Input	1-2	NA	Read Only	1-Indicates Pulse/Relay #1 is ON (Closed) 2-Indicates Pulse/Relay #2 is OFF (Open)
10002	Pulse/Relay Output 2 Status	Discreet Input	1-2	NA	Read Only	1-Indicates Pulse/Relay #1 is ON (Closed) 2-Indicates Pulse/Relay #2 is OFF (Open)
10003	Pulse/Relay Output 3 Status	Discreet Input	1-2	NA	Read Only	1-Indicates Pulse/Relay #1 is ON (Closed) 2-Indicates Pulse/Relay #2 is OFF (Open)
10004	Pulse/Relay Output 4 Status	Discreet Input	1-2	NA	Read Only	1-Indicates Pulse/Relay #1 is ON (Closed) 2-Indicates Pulse/Relay #2 is OFF (Open)
10005	Pulse/Relay Output 5 Status	Discreet Input	1-2	NA	Read Only	1-Indicates Pulse/Relay #1 is ON (Closed) 2-Indicates Pulse/Relay #2 is OFF (Open)
10006	Pulse/Relay Output 6 Status	Discreet Input	1-2	NA	Read Only	1-Indicates Pulse/Relay #1 is ON (Closed) 2-Indicates Pulse/Relay #2 is OFF (Open)

**6.1 MODBUS MEMORY MAP (CONTINUED)**

<b>Register Address</b>	<b>Description</b>	<b>Register Type</b>	<b>Register Type</b>	<b>Comments</b>
30333	Volume Total Mode 1 - Gallons	Input Register	Floating Point Register (1 of 2)	
30334	Volume Total Mode 1- Gallons	Input Register	Floating Point Register (2 of 2)	
30335	Volume Total Mode 1 - Liters	Input Register	Floating Point Register (1 of 2)	
30336	Volume Total Mode 1 - Liters	Input Register	Floating Point Register (2 of 2)	
30337	Volume Total Mode 1 - ft <sup>3</sup>	Input Register	Floating Point Register (1 of 2)	
30338	Volume Total Mode 1 - ft <sup>3</sup>	Input Register	Floating Point Register (2 of 2)	
30339	Volume Total Mode 1- m <sup>3</sup>	Input Register	Floating Point Register (1 of 2)	
30340	Volume Total Mode 1 - m <sup>3</sup>	Input Register	Floating Point Register (2 of 2)	
30341	Volume Total Mode 2 - Gallons	Input Register	Floating Point Register (1 of 2)	
30342	Volume Total Mode 2 - Gallons	Input Register	Floating Point Register (2 of 2)	
30343	Volume Total Mode 2 - Liters	Input Register	Floating Point Register (1 of 2)	
30344	Volume Total Mode 2 - Liters	Input Register	Floating Point Register (2 of 2)	
30345	Volume Total Mode 2 - ft <sup>3</sup>	Input Register	Floating Point Register (1 of 2)	
30346	Volume Total Mode 2 - ft <sup>3</sup>	Input Register	Floating Point Register (2 of 2)	
30347	Volume Total Mode 2- m <sup>3</sup>	Input Register	Floating Point Register (1 of 2)	
30348	Volume Total Mode 2 - m <sup>3</sup>	Input Register	Floating Point Register (2 of 2)	
30349	Year to Date Volume Single Mode - Gallons	Input Register	Floating Point Register (1 of 2)	
30350	Year to Date Volume Single Mode - Gallons	Input Register	Floating Point Register (2 of 2)	
30351	Year to Date Volume Single Mode - Liters	Input Register	Floating Point Register (1 of 2)	
30352	Year to Date Volume Single Mode - Liters	Input Register	Floating Point Register (2 of 2)	
30353	Year to Date Volume Single Mode - ft <sup>3</sup>	Input Register	Floating Point Register (1 of 2)	
30354	Year to Date Volume Single Mode - ft <sup>3</sup>	Input Register	Floating Point Register (2 of 2)	

**6.1 MODBUS MEMORY MAP (CONTINUED)**

<b>Register Address</b>	<b>Description</b>	<b>Register Type</b>	<b>Register Type</b>	<b>Comments</b>
30355	Year to Date Volume Single Mode - m <sup>3</sup>	Input Register	Floating Point Register (1 of 2)	
30356	Year to Date Volume Single Mode - m <sup>3</sup>	Input Register	Floating Point Register (2 of 2)	
30357	Year to Date Volume Mode 1 - Gallons	Input Register	Floating Point Register (1 of 2)	
30358	Year to Date Volume Mode 1 - Gallons	Input Register	Floating Point Register (2 of 2)	
30359	Year to Date Volume Mode 1 - Liters	Input Register	Floating Point Register (1 of 2)	
30360	Year to Date Volume Mode 1 - Liters	Input Register	Floating Point Register (2 of 2)	
30361	Year to Date Volume Mode 1 - ft <sup>3</sup>	Input Register	Floating Point Register (1 of 2)	
30362	Year to Date Volume Mode 1 - ft <sup>3</sup>	Input Register	Floating Point Register (2 of 2)	
30363	Year to Date Volume Mode 1 - m <sup>3</sup>	Input Register	Floating Point Register (1 of 2)	
30364	Year to Date Volume Mode 1 - m <sup>3</sup>	Input Register	Floating Point Register (2 of 2)	
30365	Year to Date Volume Mode 2 - Gallons	Input Register	Floating Point Register (1 of 2)	
30366	Year to Date Volume Mode 2 - Gallons	Input Register	Floating Point Register (2 of 2)	
30367	Year to Date Volume Mode 2 - Liters	Input Register	Floating Point Register (1 of 2)	
30368	Year to Date Volume Mode 2 - Liters	Input Register	Floating Point Register (2 of 2)	
30369	Year to Date Volume Mode 2 - ft <sup>3</sup>	Input Register	Floating Point Register (1 of 2)	
30370	Year to Date Volume Mode 2 - ft <sup>3</sup>	Input Register	Floating Point Register (2 of 2)	
30371	Year to Date Volume Mode 2 - m <sup>3</sup>	Input Register	Floating Point Register (1 of 2)	
30372	Year to Date Volume Mode 2 - m <sup>3</sup>	Input Register	Floating Point Register (2 of 2)	
30373	Previous Year Volume Single Mode - Gallons	Input Register	Floating Point Register (1 of 2)	
30374	Previous Year Volume Single Mode - Gallons	Input Register	Floating Point Register (2 of 2)	
30375	Previous Year Volume Single Mode - Liters	Input Register	Floating Point Register (1 of 2)	
30376	Previous Year Volume Single Mode - Liters	Input Register	Floating Point Register (2 of 2)	
30377	Previous Year Volume Single Mode - ft <sup>3</sup>	Input Register	Floating Point Register (1 of 2)	

**6.1 MODBUS MEMORY MAP (CONTINUED)**

<b>Register Address</b>	<b>Description</b>	<b>Register Type</b>	<b>Register Type</b>	<b>Comments</b>
30378	Previous Year Volume Single Mode - ft <sup>3</sup>	Input Register	Floating Point Register (2 of 2)	
30379	Previous Year Volume Single Mode - m <sup>3</sup>	Input Register	Floating Point Register (1 of 2)	
30380	Previous Year Volume Single Mode - m <sup>3</sup>	Input Register	Floating Point Register (2 of 2)	
30381	Previous Year Volume Mode 1 - Gallons	Input Register	Floating Point Register (1 of 2)	
30382	Previous Year Volume Mode 1 - Gallons	Input Register	Floating Point Register (2 of 2)	
30383	Previous Year Volume Mode 1 - Liters	Input Register	Floating Point Register (1 of 2)	
30384	Previous Year Volume Mode 1 - Liters	Input Register	Floating Point Register (2 of 2)	
30385	Previous Year Volume Mode 1 - ft <sup>3</sup>	Input Register	Floating Point Register (1 of 2)	
30386	Previous Year Volume Mode 1 - ft <sup>3</sup>	Input Register	Floating Point Register (2 of 2)	
30387	Previous Year Volume Mode 1 - m <sup>3</sup>	Input Register	Floating Point Register (1 of 2)	
30388	Previous Year Volume Mode 1 - m <sup>3</sup>	Input Register	Floating Point Register (2 of 2)	
30389	Previous Year Volume Mode 2 - Gallons	Input Register	Floating Point Register (1 of 2)	
30390	Previous Year Volume Mode 2 - Gallons	Input Register	Floating Point Register (2 of 2)	
30391	Previous Year Volume Mode 2 - Liters	Input Register	Floating Point Register (1 of 2)	
30392	Previous Year Volume Mode 2 - Liters	Input Register	Floating Point Register (2 of 2)	
30393	Previous Year Volume Mode 2 - ft <sup>3</sup>	Input Register	Floating Point Register (1 of 2)	
30394	Previous Year Volume Mode 2 - ft <sup>3</sup>	Input Register	Floating Point Register (2 of 2)	
30395	Previous Year Volume Mode 2 - m <sup>3</sup>	Input Register	Floating Point Register (1 of 2)	
30396	Previous Year Volume Mode 2 - m <sup>3</sup>	Input Register	Floating Point Register (2 of 2)	
30397	User Defined Volume Single Mode - Gallons	Input Register	Floating Point Register (1 of 2)	
30398	User Defined Volume Single Mode - Gallons	Input Register	Floating Point Register (2 of 2)	
30399	User Defined Volume Single Mode - Liters	Input Register	Floating Point Register (1 of 2)	

**6.1 MODBUS MEMORY MAP (CONTINUED)**

<b>Register Address</b>	<b>Description</b>	<b>Register Type</b>	<b>Register Type</b>	<b>Comments</b>
30400	User Defined Volume Single Mode - Liters	Input Register	Floating Point Register (2 of 2)	
30401	User Defined Volume Single Mode - ft <sup>3</sup>	Input Register	Floating Point Register (1 of 2)	
30402	User Defined Volume Single Mode - ft <sup>3</sup>	Input Register	Floating Point Register (2 of 2)	
30403	User Defined Volume Single Mode - m <sup>3</sup>	Input Register	Floating Point Register (1 of 2)	
30404	User Defined Volume Single Mode - m <sup>3</sup>	Input Register	Floating Point Register (2 of 2)	
30405	User Defined Volume Mode 1 - Gallons	Input Register	Floating Point Register (1 of 2)	
30406	User Defined Volume Mode 1 - Gallons	Input Register	Floating Point Register (2 of 2)	
30407	User Defined Volume Mode 1 - Liters	Input Register	Floating Point Register (1 of 2)	
30408	User Defined Volume Mode 1 - Liters	Input Register	Floating Point Register (2 of 2)	
30409	User Defined Volume Mode 1 - ft <sup>3</sup>	Input Register	Floating Point Register (1 of 2)	
30410	User Defined Volume Mode 1 - ft <sup>3</sup>	Input Register	Floating Point Register (2 of 2)	
30411	User Defined Volume Mode 1 - m <sup>3</sup>	Input Register	Floating Point Register (1 of 2)	
30412	User Defined Volume Mode 1 - m <sup>3</sup>	Input Register	Floating Point Register (2 of 2)	
30413	User Defined Volume Mode 2 - Gallons	Input Register	Floating Point Register (1 of 2)	
30414	User Defined Volume Mode 2 - Gallons	Input Register	Floating Point Register (2 of 2)	
30415	User Defined Volume Mode 2 - Liters	Input Register	Floating Point Register (1 of 2)	
30416	User Defined Volume Mode 2 - Liters	Input Register	Floating Point Register (2 of 2)	
30417	User Defined Volume Mode 2 - ft <sup>3</sup>	Input Register	Floating Point Register (1 of 2)	
30418	User Defined Volume Mode 2 - ft <sup>3</sup>	Input Register	Floating Point Register (2 of 2)	
30419	User Defined Volume Mode 2 - m <sup>3</sup>	Input Register	Floating Point Register (1 of 2)	
30420	User Defined Volume Mode 2 - m <sup>3</sup>	Input Register	Floating Point Register (2 of 2)	
30701	Energy Rate - kBtu/hr	Input Register	Floating Point Register (1 of 2)	

**6.1 MODBUS MEMORY MAP (CONTINUED)**

<b>Register Address</b>	<b>Description</b>	<b>Register Type</b>	<b>Register Type</b>	<b>Comments</b>
30702	Energy Rate - kBtu/hr	Input Register	Floating Point Register (2 of 2)	
30703	Energy Rate - Tons	Input Register	Floating Point Register (1 of 2)	
30704	Energy Rate -Tons	Input Register	Floating Point Register (2 of 2)	
30705	Energy Rate - kW	Input Register	Floating Point Register (1 of 2)	
30706	Energy Rate - kW	Input Register	Floating Point Register (2 of 2)	
30707	Energy Rate - MW	Input Register	Floating Point Register (1 of 2)	
30708	Energy Rate - MW	Input Register	Floating Point Register (2 of 2)	
30709	Flow Temperature - F	Input Register	Floating Point Register (1 of 2)	
30710	Flow Temperature - F	Input Register	Floating Point Register (2 of 2)	
30711	Flow Temperature - C	Input Register	Floating Point Register (1 of 2)	
30712	Flow Temperature - C	Input Register	Floating Point Register (2 of 2)	
30713	Remote Temperature - F	Input Register	Floating Point Register (1 of 2)	
30714	Remote Temperature - F	Input Register	Floating Point Register (2 of 2)	
30715	Remote Temperature - C	Input Register	Floating Point Register (1 of 2)	
30716	Remote Temperature - C	Input Register	Floating Point Register (2 of 2)	
30717	Delta Temperature - F	Input Register	Floating Point Register (1 of 2)	
30718	Delta Temperature - F	Input Register	Floating Point Register (2 of 2)	
30719	Delta Temperature - C	Input Register	Floating Point Register (1 of 2)	
30720	Delta Temperature - C	Input Register	Floating Point Register (2 of 2)	
30751	Energy Total Single Mode - kBtu	Input Register	Floating Point Register (1 of 2)	
30752	Energy Total Single Mode - kBtu	Input Register	Floating Point Register (2 of 2)	
30753	Energy Total Single Mode - MBtu	Input Register	Floating Point Register (1 of 2)	

**6.1 MODBUS MEMORY MAP (CONTINUED)**

<b>Register Address</b>	<b>Description</b>	<b>Register Type</b>	<b>Register Type</b>	<b>Comments</b>
30754	Energy Total Single Mode - MBtu	Input Register	Floating Point Register (2 of 2)	
30755	Energy Total Single Mode - TonHr	Input Register	Floating Point Register (1 of 2)	
30756	EnergyTotal Single Mode - TonHr	Input Register	Floating Point Register (2 of 2)	
30757	Energy Total Single Mode - MJ	Input Register	Floating Point Register (1 of 2)	
30758	Energy Total Single Mode - MJ	Input Register	Floating Point Register (2 of 2)	
30759	Energy Total Single Mode - kWhr	Input Register	Floating Point Register (1 of 2)	
30760	Energy Total Single Mode - kWhr	Input Register	Floating Point Register (2 of 2)	
30761	Energy Total Mode 1 - kBtu	Input Register	Floating Point Register (1 of 2)	
30762	Energy Total Mode 1 - kBtu	Input Register	Floating Point Register (2 of 2)	
30763	Energy Total Mode 1 - Mbtu	Input Register	Floating Point Register (1 of 2)	
30764	Energy Total Mode 1 - MBtu	Input Register	Floating Point Register (2 of 2)	
30765	Energy Total Mode 1 - TonHr	Input Register	Floating Point Register (1 of 2)	
30766	EnergyTotal Mode 1 - TonHr	Input Register	Floating Point Register (2 of 2)	
30767	Energy Total Mode 1 - MJ	Input Register	Floating Point Register (1 of 2)	
30768	Energy Total Mode 1 - MJ	Input Register	Floating Point Register (2 of 2)	
30769	Energy Total Mode 1 - kWhr	Input Register	Floating Point Register (1 of 2)	
30770	Energy Total Mode 1 - kWhr	Input Register	Floating Point Register (2 of 2)	
30771	Energy Total Mode 2 - kBtu	Input Register	Floating Point Register (2 of 2)	
30772	Energy Total Mode 2 - kBtu	Input Register	Floating Point Register (1 of 2)	
30773	Energy Total Mode 2 - MBtu	Input Register	Floating Point Register (2 of 2)	
30774	Energy Total Mode 2 - MBtu	Input Register	Floating Point Register (1 of 2)	
30775	Energy Total Mode 2 - TonHr	Input Register	Floating Point Register (2 of 2)	



6.1 MODBUS MEMORY MAP (CONTINUED)

Register Address	Description	Register Type	Register Type	Comments
30776	EnergyTotal Mode 2 - TonHr	Input Register	Floating Point Register (1 of 2)	
30777	Energy Total Mode 2 - MJ	Input Register	Floating Point Register (2 of 2)	
30778	Energy Total Mode 2 - MJ	Input Register	Floating Point Register (1 of 2)	
30779	Energy Total Mode 2 - kWhr	Input Register	Floating Point Register (2 of 2)	
30780	Energy Total Mode 2 - kWhr	Input Register	Floating Point Register (1 of 2)	
30781	Year to Date Energy Total Single Mode - kBtu	Input Register	Floating Point Register (1 of 2)	
30782	Year to Date Energy Total Single Mode - kBtu	Input Register	Floating Point Register (2 of 2)	
30783	Year to Date Energy Total Single Mode - MBtu	Input Register	Floating Point Register (1 of 2)	
30784	Year to Date Energy Total Single Mode - MBtu	Input Register	Floating Point Register (2 of 2)	
30785	Year to Date Energy Total Single Mode - TonHr	Input Register	Floating Point Register (1 of 2)	
30786	Year to Date EnergyTotal Single Mode - TonHr	Input Register	Floating Point Register (2 of 2)	
30787	Year to Date Energy Total Single Mode - MJ	Input Register	Floating Point Register (1 of 2)	
30788	Year to Date Energy Total Single Mode - MJ	Input Register	Floating Point Register (2 of 2)	
30789	Year to Date Energy Total Single Mode - kWhr	Input Register	Floating Point Register (1 of 2)	
30790	Year to Date Energy Total Single Mode - kWhr	Input Register	Floating Point Register (2 of 2)	
30791	Year to Date Energy Total Mode 1 - kBtu	Input Register	Floating Point Register (1 of 2)	
30792	Year to Date Energy Total Mode 1 - kBtu	Input Register	Floating Point Register (2 of 2)	
30793	Year to Date Energy Total Mode 1 - MBtu	Input Register	Floating Point Register (1 of 2)	
30794	Year to Date Energy Total Mode 1 - MBtu	Input Register	Floating Point Register (2 of 2)	
30795	Year to Date Energy Total Mode 1 - TonHr	Input Register	Floating Point Register (1 of 2)	
30796	Year to Date EnergyTotal Mode 1 - TonHr	Input Register	Floating Point Register (2 of 2)	
30797	Year to Date Energy Total Mode 1 - MJ	Input Register	Floating Point Register (1 of 2)	
30798	Year to Date Energy Total Mode 1 - MJ	Input Register	Floating Point Register (2 of 2)	



**6.1 MODBUS MEMORY MAP (CONTINUED)**

<b>Register Address</b>	<b>Description</b>	<b>Register Type</b>	<b>Register Type</b>	<b>Comments</b>
30799	Year to Date Energy Total Mode 1 - kWhr	Input Register	Floating Point Register (1 of 2)	
30800	Year to Date Energy Total Mode 1 - kWhr	Input Register	Floating Point Register (2 of 2)	
30801	Year to Date Energy Total Mode 2 - kBtu	Input Register	Floating Point Register (2 of 2)	
30802	Year to Date Energy Total Mode 2 - kBtu	Input Register	Floating Point Register (1 of 2)	
30803	Year to Date Energy Total Mode 2 - MBtu	Input Register	Floating Point Register (2 of 2)	
30804	Year to Date Energy Total Mode 2 - MBtu	Input Register	Floating Point Register (1 of 2)	
30805	Year to Date Energy Total Mode 2 - TonHr	Input Register	Floating Point Register (2 of 2)	
30806	Year to Date Energy Total Mode 2 - TonHr	Input Register	Floating Point Register (1 of 2)	
30807	Year to Date Energy Total Mode 2 - MJ	Input Register	Floating Point Register (2 of 2)	
30808	Year to Date Energy Total Mode 2 - MJ	Input Register	Floating Point Register (1 of 2)	
30809	Year to Date Energy Total Mode 2 - kWhr	Input Register	Floating Point Register (2 of 2)	
30810	Year to Date Energy Total Mode 2 - kWhr	Input Register	Floating Point Register (1 of 2)	
30811	Previous Year Energy Total Single Mode - kBtu	Input Register	Floating Point Register (1 of 2)	
30812	Previous Year Energy Total Single Mode - kBtu	Input Register	Floating Point Register (2 of 2)	
30813	Previous Year Energy Total Single Mode - MBtu	Input Register	Floating Point Register (1 of 2)	
30814	Previous Year Energy Total Single Mode - MBtu	Input Register	Floating Point Register (2 of 2)	
30815	Previous Year Energy Total Single Mode - TonHr	Input Register	Floating Point Register (1 of 2)	
30816	Previous Year Energy Total Single Mode - TonHr	Input Register	Floating Point Register (2 of 2)	
30817	Previous Year Energy Total Single Mode - MJ	Input Register	Floating Point Register (1 of 2)	
30818	Previous Year Energy Total Single Mode - MJ	Input Register	Floating Point Register (2 of 2)	
30819	Previous Year Energy Total Single Mode - kWhr	Input Register	Floating Point Register (1 of 2)	
30820	Previous Year Energy Total Single Mode - kWhr	Input Register	Floating Point Register (2 of 2)	

**6.1 MODBUS MEMORY MAP (CONTINUED)**

<b>Register Address</b>	<b>Description</b>	<b>Register Type</b>	<b>Register Type</b>	<b>Comments</b>
30821	Previous Year Energy Total Mode 1 - kBtu	Input Register	Floating Point Register (1 of 2)	
30822	Previous Year Energy Total Mode 1 - kBtu	Input Register	Floating Point Register (2 of 2)	
30823	Previous Year Energy Total Mode 1 - MBtu	Input Register	Floating Point Register (1 of 2)	
30824	Previous Year Energy Total Mode 1 - MBtu	Input Register	Floating Point Register (2 of 2)	
30825	Previous Year Energy Total Mode 1 - TonHr	Input Register	Floating Point Register (1 of 2)	
30826	Previous Year Energy Total Mode 1 - TonHr	Input Register	Floating Point Register (2 of 2)	
30827	Previous Year Energy Total Mode 1 - MJ	Input Register	Floating Point Register (1 of 2)	
30828	Previous Year Energy Total Mode 1 - MJ	Input Register	Floating Point Register (2 of 2)	
30829	Previous Year Energy Total Mode 1 - kWhr	Input Register	Floating Point Register (1 of 2)	
30830	Previous Year Energy Total Mode 1 - kWhr	Input Register	Floating Point Register (2 of 2)	
30831	Previous Year Energy Total Mode 2 - kBtu	Input Register	Floating Point Register (2 of 2)	
30832	Previous Year Energy Total Mode 2 - kBtu	Input Register	Floating Point Register (1 of 2)	
30833	Previous Year Energy Total Mode 2 - MBtu	Input Register	Floating Point Register (2 of 2)	
30834	Previous Year Energy Total Mode 2 - MBtu	Input Register	Floating Point Register (1 of 2)	
30835	Previous Year Energy Total Mode 2 - TonHr	Input Register	Floating Point Register (2 of 2)	
30836	Previous Year Energy Total Mode 2 - TonHr	Input Register	Floating Point Register (1 of 2)	
30837	Previous Year Energy Total Mode 2 - MJ	Input Register	Floating Point Register (2 of 2)	
30838	Previous Year Energy Total Mode 2 - MJ	Input Register	Floating Point Register (1 of 2)	
30839	Previous Year Energy Total Mode 2 - kWhr	Input Register	Floating Point Register (2 of 2)	
30840	Previous Year Energy Total Mode 2 - kWhr	Input Register	Floating Point Register (1 of 2)	
30841	User Defined Energy Total Single Mode - kBtu	Input Register	Floating Point Register (1 of 2)	
30842	User Defined Energy Total Single Mode - kBtu	Input Register	Floating Point Register (2 of 2)	

**6.1 MODBUS MEMORY MAP (CONTINUED)**

<b>Register Address</b>	<b>Description</b>	<b>Register Type</b>	<b>Register Type</b>	<b>Comments</b>
30843	User Defined Energy Total Single Mode - MBtu	Input Register	Floating Point Register (1 of 2)	
30844	User Defined Energy Total Single Mode - MBtu	Input Register	Floating Point Register (2 of 2)	
30845	User Defined Energy Total Single Mode - TonHr	Input Register	Floating Point Register (1 of 2)	
30846	User Defined EnergyTotal Single Mode - TonHr	Input Register	Floating Point Register (2 of 2)	
30847	User Defined Energy Total Single Mode - MJ	Input Register	Floating Point Register (1 of 2)	
30848	User Defined Energy Total Single Mode - MJ	Input Register	Floating Point Register (2 of 2)	
30849	User Defined Energy Total Single Mode - kWhr	Input Register	Floating Point Register (1 of 2)	
30850	User Defined Energy Total Single Mode - kWhr	Input Register	Floating Point Register (2 of 2)	
30851	User Defined Energy Total Mode 1 - kBtu	Input Register	Floating Point Register (1 of 2)	
30852	User Defined Energy Total Mode 1 - kBtu	Input Register	Floating Point Register (2 of 2)	
30853	User Defined Energy Total Mode 1 - Mbtu	Input Register	Floating Point Register (1 of 2)	
30854	User Defined Energy Total Mode 1 - MBtu	Input Register	Floating Point Register (2 of 2)	
30855	User Defined Energy Total Mode 1 - TonHr	Input Register	Floating Point Register (1 of 2)	
30856	User Defined EnergyTotal Mode 1 - TonHr	Input Register	Floating Point Register (2 of 2)	
30857	User Defined Energy Total Mode 1 - MJ	Input Register	Floating Point Register (1 of 2)	
30858	User Defined Energy Total Mode 1 - MJ	Input Register	Floating Point Register (2 of 2)	
30859	User Defined Energy Total Mode 1 - kWhr	Input Register	Floating Point Register (1 of 2)	
30860	User Defined Energy Total Mode 1 - kWhr	Input Register	Floating Point Register (2 of 2)	
30861	User Defined Energy Total Mode 2 - kBtu	Input Register	Floating Point Register (2 of 2)	
30862	User Defined Energy Total Mode 2 - kBtu	Input Register	Floating Point Register (1 of 2)	
30863	User Defined Energy Total Mode 2 - Mbtu	Input Register	Floating Point Register (2 of 2)	
30864	User Defined Energy Total Mode 2 - MBtu	Input Register	Floating Point Register (1 of 2)	

**6.1 MODBUS MEMORY MAP (CONTINUED)**

<b>Register Address</b>	<b>Description</b>	<b>Register Type</b>	<b>Register Type</b>	<b>Comments</b>
30865	User Defined Energy Total Mode 2 - TonHr	Input Register	Floating Point Register (2 of 2)	
30866	User Defined EnergyTotal Mode 2 - TonHr	Input Register	Floating Point Register (1 of 2)	
30867	User Defined Energy Total Mode 2 - MJ	Input Register	Floating Point Register (2 of 2)	
30868	User Defined Energy Total Mode 2 - MJ	Input Register	Floating Point Register (1 of 2)	
30869	User Defined Energy Total Mode 2 - kWhr	Input Register	Floating Point Register (2 of 2)	
30870	User Defined Energy Total Mode 2 - kWhr	Input Register	Floating Point Register (1 of 2)	
30871	Auxiliary Pulse Input Count - Input 1	Input Register	Int 32 Register (1 of 2)	
30872	Auxiliary Pulse Input Count - Input 1	Input Register	Int 32 Register (2 of 2)	
30873	Auxiliary Pulse Input Count - Input 2	Input Register	Int 32 Register (1 of 2)	
30874	Auxiliary Pulse Input Count - Input 2	Input Register	Int 32 Register (2 of 2)	
30875	Auxiliary Pulse Input Count - Input 3	Input Register	Int 32 Register (1 of 2)	
30876	Auxiliary Pulse Input Count - Input 3	Input Register	Int 32 Register (2 of 2)	

**6.1 MODBUS MEMORY MAP (CONTINUED)**

<b>Register Address</b>	<b>Description</b>	<b>Register Type</b>	<b>Register Type</b>	<b>Comments</b>
40001	Dampening - %	Holding Register	Integer	0-100
40002	Min Flow (Cutoff)	Holding Register	Floating Point (1 of 2)	Units match those programmed in meter
40003	Min Flow (Cutoff)	Holding Register	Floating Point (2 of 2)	Units match those programmed in meter
40004	Signal Cutoff - %	Holding Register	Integer	0-100
40005	LOE Time	Holding Register	Integer	0-99



---

ONICON Incorporated • 11451 Belcher Road South • Largo, FL 33773 • USA  
(P) 727.447.6140 • (F) 727.442.5699 • [onicon.com](http://onicon.com)